

Pencil Control: Pattern Worksheet 1

Can you follow the lines to make the patterns?

The worksheet contains seven rows of handwriting practice. Each row is defined by two horizontal lines, with a thick purple line above and below. The first row is split by a vertical purple line. The left side shows a solid purple zigzag pattern with colored dots (blue, red, yellow, orange, purple) at the vertices. The right side shows a dashed purple zigzag pattern with the same colored dots. The second row shows a solid purple zigzag followed by dashed zigzags with colored dots. The third row shows a dashed zigzag followed by a solid zigzag with colored dots. The fourth row shows a dashed zigzag followed by a solid zigzag with colored dots. The fifth row shows a dashed zigzag followed by a solid zigzag with colored dots. The sixth row shows a dashed zigzag followed by a solid zigzag with colored dots. The seventh row shows a dashed zigzag followed by a solid zigzag with colored dots.

Pencil Control: Pattern Worksheet 2

Can you follow the lines to make the patterns?

The worksheet consists of seven rows of pencil control exercises, each bounded by two horizontal purple lines. The first row is split into two sections by a vertical purple line. The left section shows a solid purple zigzag line with colored dots (blue, red, yellow, green, red, purple) and arrows indicating direction. The right section shows a dashed purple zigzag line with colored dots and arrows. The second row shows a solid purple zigzag line followed by a dashed purple zigzag line. The third row shows a solid purple zigzag line followed by a dashed purple zigzag line. The fourth row shows a solid purple zigzag line followed by a dashed purple zigzag line. The fifth row shows a solid purple zigzag line followed by a dashed purple zigzag line. The sixth row shows a solid purple zigzag line followed by a dashed purple zigzag line. The seventh row shows a solid purple zigzag line followed by a dashed purple zigzag line.

Pencil Control: Pattern Worksheet 3

Can you follow the lines to make the patterns?

The worksheet consists of seven rows of handwriting practice. Each row is bounded by two thick purple horizontal lines. Inside, there are two thin black horizontal lines. The first arch in each row is a solid purple line connecting a blue dot on the bottom line to a red dot on the top line. The following arches are dashed lines connecting various colored dots on the bottom line to dots on the top line. The colors of the dots include yellow, orange, purple, red, green, cyan, and blue. Small arrows on the left of each row indicate the starting point and direction of the stroke.

Pencil Control: Pattern Worksheet 4

Can you follow the lines to make the patterns?

The worksheet consists of seven rows of handwriting practice on purple-lined paper. Each row contains a sequence of arches and horizontal lines. The first row is split into two sections by a vertical line. The first section shows two solid purple arches, each starting with a blue dot on the left and ending with a purple dot on the right. The second section shows two dashed purple arches, each starting with a green dot on the left and ending with a red dot on the right. The second row shows a large solid purple arch followed by a dashed purple arch, then a dashed purple arch followed by a dashed purple arch. The third row shows a solid purple arch followed by three dashed purple arches. The fourth row shows a solid purple arch followed by a dashed purple arch, then a row of four scattered colored dots (blue, red, green, orange). The fifth row shows a solid purple arch followed by a dashed purple arch, then a row of six scattered colored dots (blue, red, green, red, cyan, blue). The sixth row shows a solid purple arch followed by a dashed purple arch, then a row of eight scattered colored dots (blue, red, green, red, purple, cyan, blue, yellow). The seventh row shows a solid purple arch followed by five dashed purple arches, then a row of ten scattered colored dots (purple, red, cyan, blue, green, red, cyan, blue, yellow, green).

Pencil Control: Pattern Worksheet 5

Can you follow the lines to make the patterns?

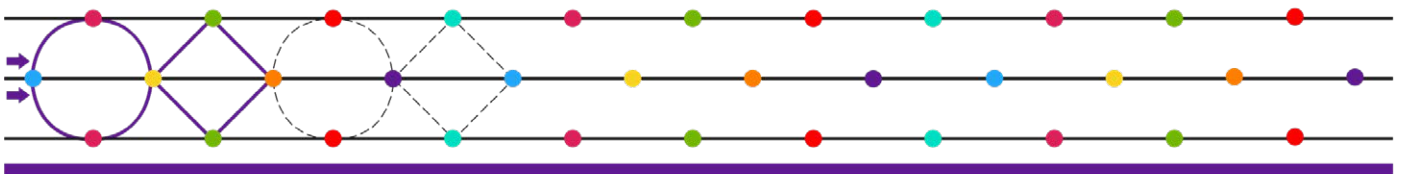
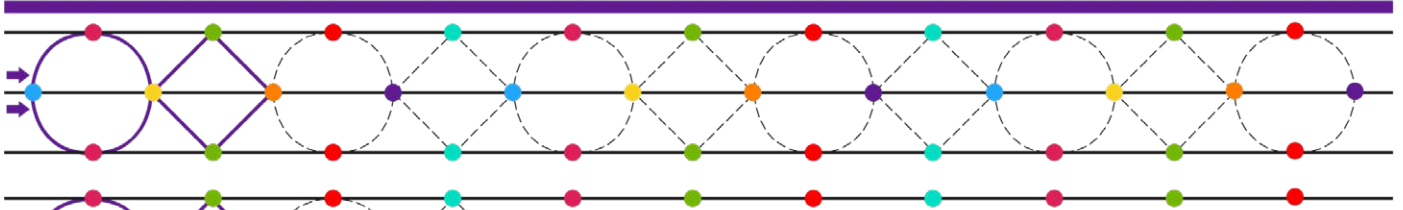
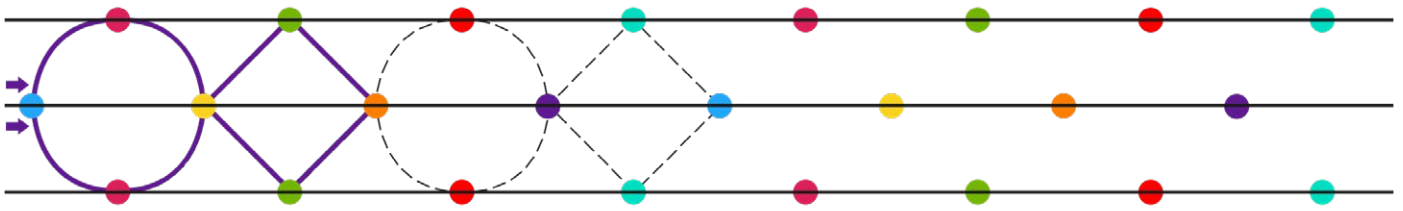
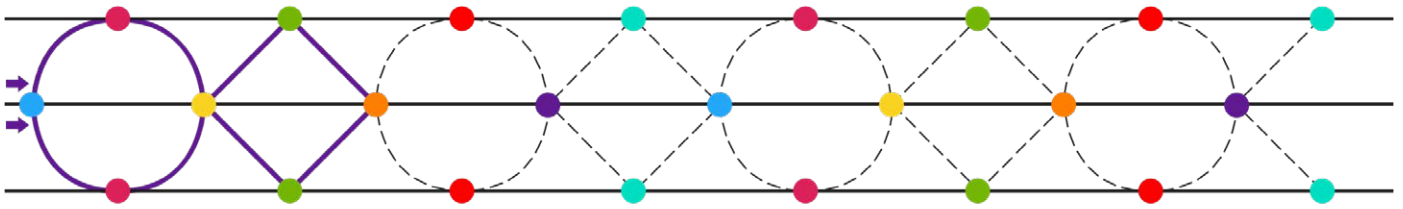
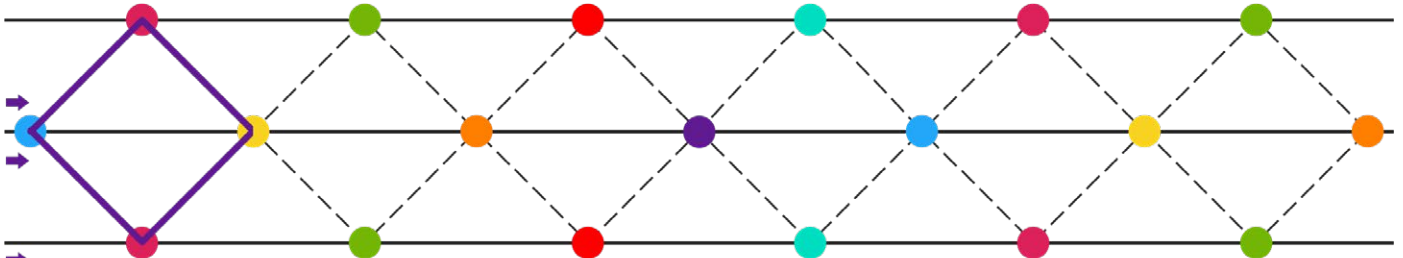
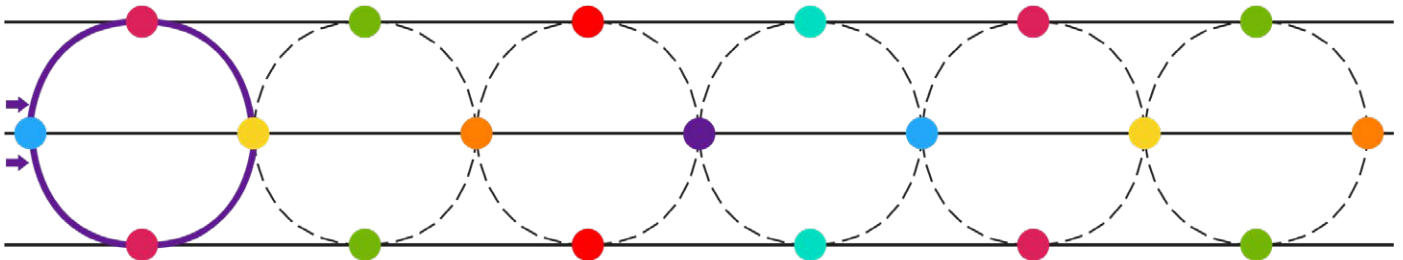
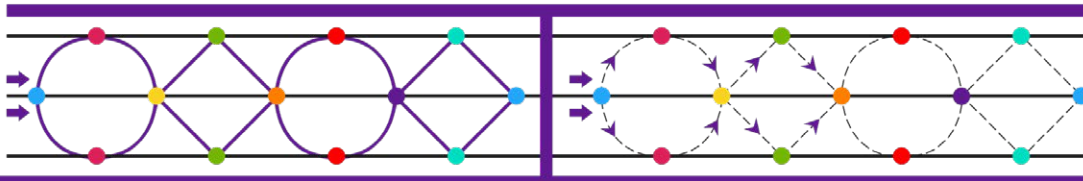

Pencil Control: Pattern Worksheet 6

Can you follow the lines to make the patterns?

The worksheet is divided into four sections, each containing two rows of handwriting practice lines. The first row in each section shows a pattern of colored dots (blue, red, yellow, green, orange, red, purple) connected by solid lines with arrows indicating direction. The second row shows the same pattern with dashed lines for tracing. The patterns include arches, triangles, and zig-zags. A vertical purple bar separates the first two sections.

Pencil Control: Pattern Worksheet 7

Can you follow the lines to make the patterns?

The worksheet consists of seven vertical tracks, each with a thick purple vertical line on the left side. The tracks contain various patterns of colored dots (blue, yellow, green, orange, red, purple, cyan) and dashed lines. The first track shows a completed pattern with solid lines. The second track shows a dashed zig-zag pattern. The third track shows a dashed zig-zag pattern with a solid arrow indicating the start. The fourth track shows a dashed loop pattern. The fifth track shows a dashed loop pattern with a solid arrow indicating the start. The sixth track shows a dashed zig-zag pattern with a solid arrow indicating the start. The seventh track shows a dashed zig-zag pattern with a solid arrow indicating the start.

Pencil Control: Pattern Worksheet 8

Can you follow the lines to make the patterns?

The worksheet consists of several rows of handwriting practice on four-line guides. Each row contains a sequence of shapes: a solid purple diamond, followed by dashed diamonds, circles, and zig-zags. The shapes are connected by lines and have colored dots at their vertices. Some shapes are solid purple, while others are dashed. Small arrows indicate the starting point and direction of the stroke. The rows are separated by thick purple horizontal lines.

__ed



cu__

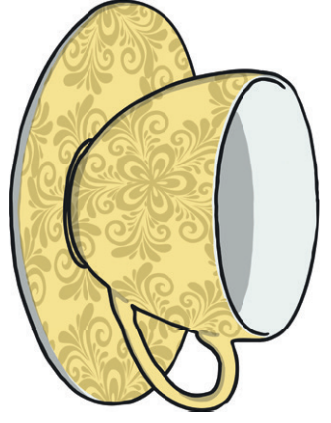

s__n

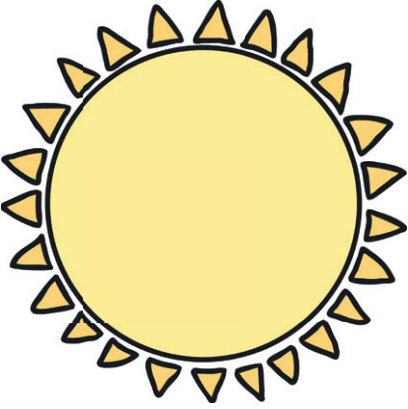

do__

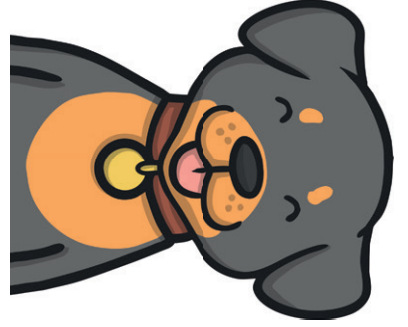

pe__



__ag

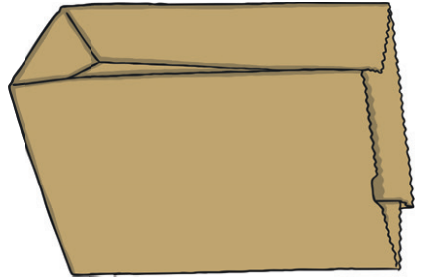

ba__



ja__

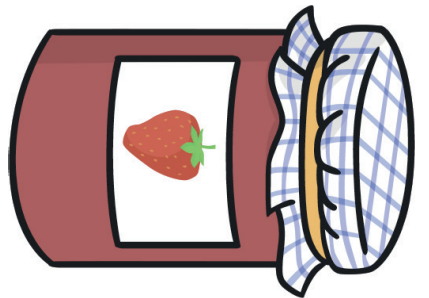

ru _ _

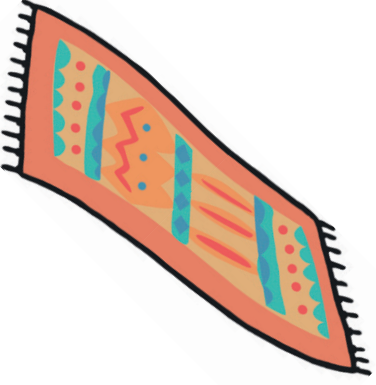

r _ _ n



_ _ in

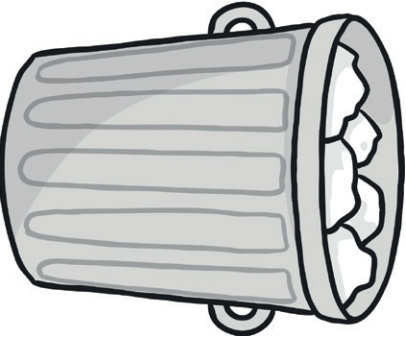

ra _ _



_ _ at



d _ _ g



_ _ an



_ _ en

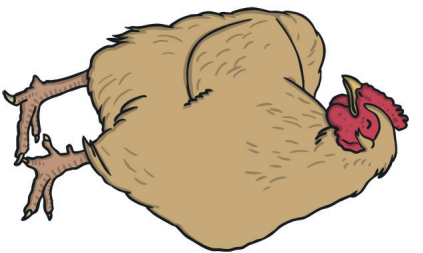

__ox

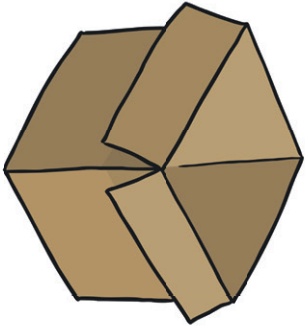

twinkl.co.uk

l__p

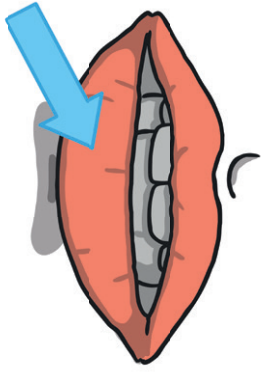

twinkl.co.uk

pi__

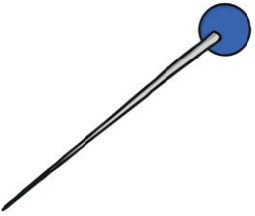

twinkl.co.uk

ju__

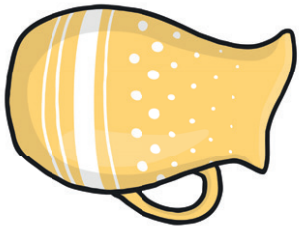

twinkl.co.uk

f__n

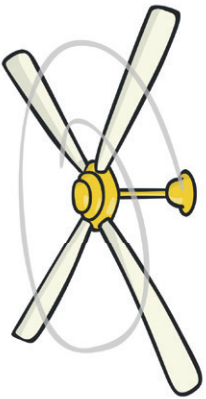

twinkl.co.uk

__ig

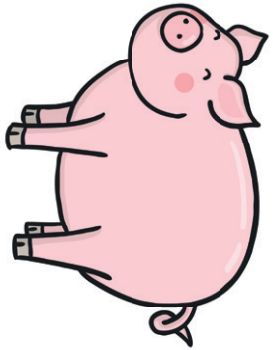

twinkl.co.uk

b__y

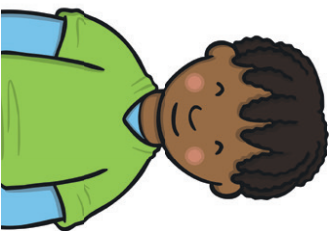

twinkl.co.uk

l__g



twinkl.co.uk

k

c

p

g

t

n

t

b

r

m

b

n

t

l

r

u

i

o

t

n

p

c

m

b

u

y

o

m

t

g

o

j

i

h

t

p

k

g

n

b

p

f

b

m

c

i

v

a

o

b

g

n

b

p



Daily Kind Acts

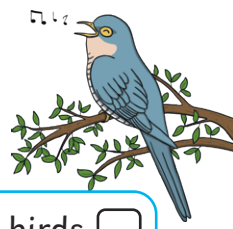

Tell someone how much you love them.

Help make dinner.

Feed the birds.

Leave a happy note somewhere for someone to find.

Teach someone something new.

Give someone a hug to show how much you care.

Smile at everybody.

Make a get-well card for someone.

Tidy your bedroom without being asked.

Give someone a compliment.

Write a list of things you are grateful for.

Make someone else's bed (as well as your own).

Pick up some litter.



Tell someone three things you love about them.

Do something nice for a neighbour.

Drink lots of water. It's much easier to be kind when you feel healthy and energetic.

Write and send a letter to someone.

Complain less (or not at all)!

Leave something on the doorstep for a next-door neighbour.

Make a positivity poster.

Remember to say please and thank you.

Use less energy to be kind to our planet.

Draw a picture for a friend, neighbour or family member.

Tell a joke, watch a silly video or do something that makes you and others laugh!

Recycle paper. Try to be as inventive and creative as you can with it!

Share something you love with a friend or family member.

Say good morning and goodnight to everyone in your household.

Hide little messages around the house for others to find.

Offer to help a family member with something.

Practice self-kindness by doing something you enjoy.



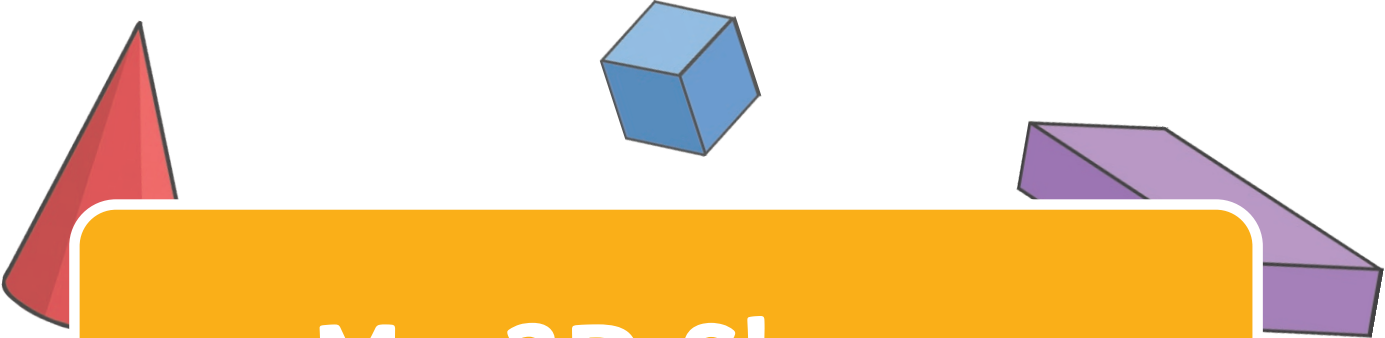

My 3D Shapes Activity Booklet

Name:

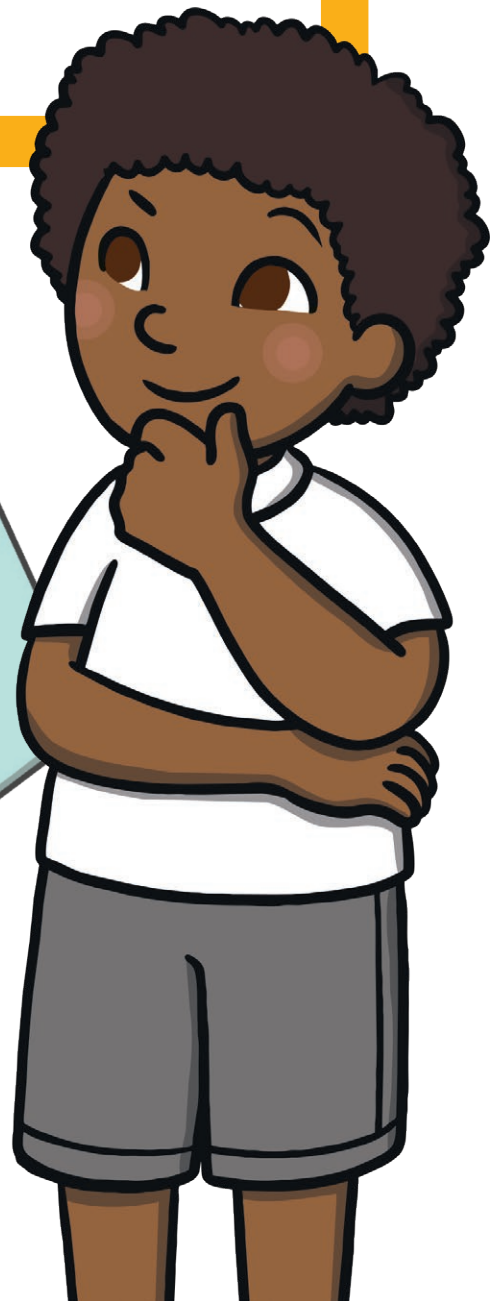
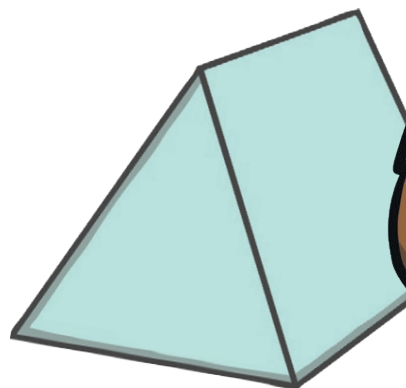
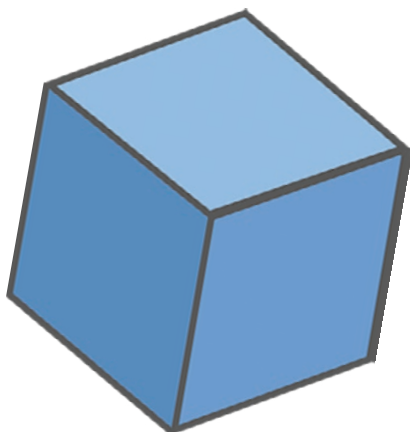
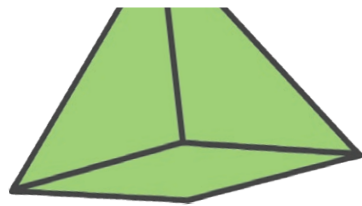
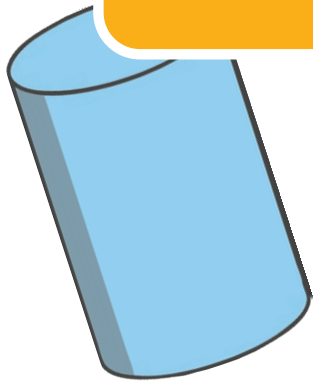

3D Shape Colouring

Use the key to colour in the 3D shapes correctly.

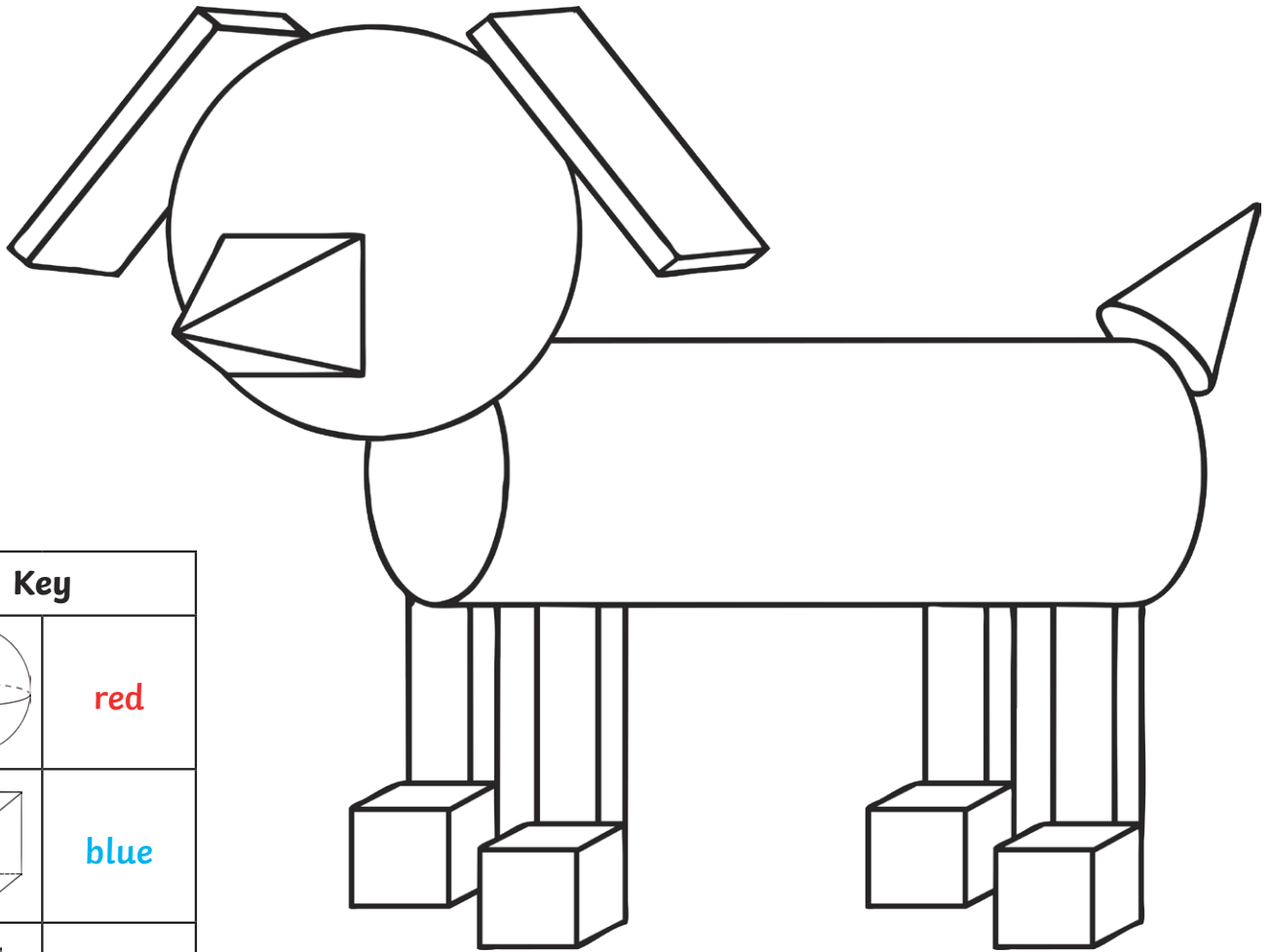

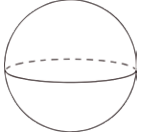
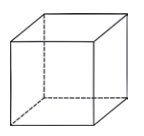
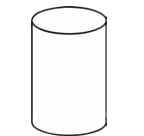
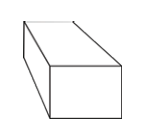
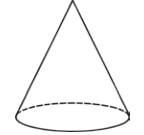
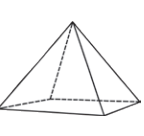

Key	
	red
	blue
	green
	purple
	orange
	yellow

3D Shape Colouring

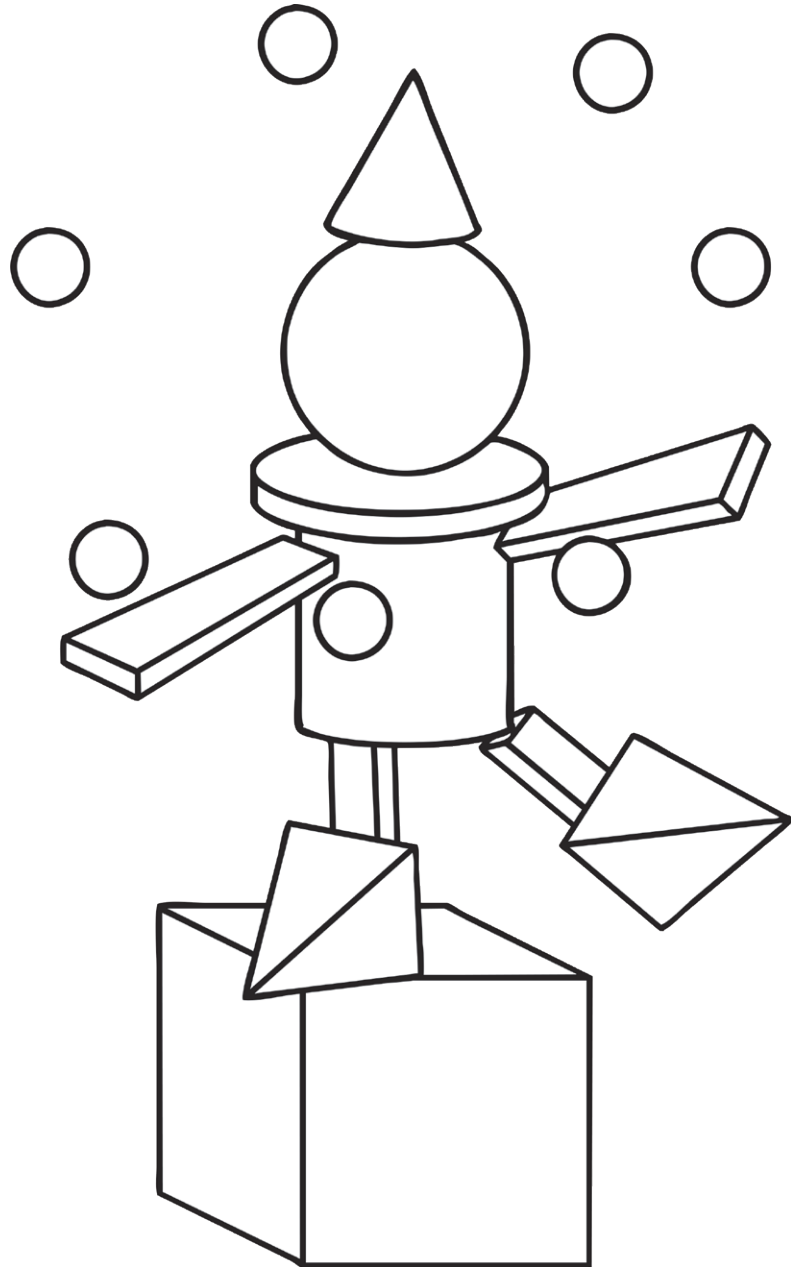
Use the key to colour in the 3D shapes correctly.

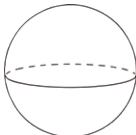
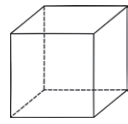
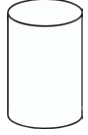
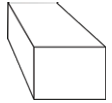
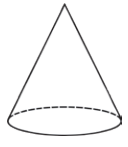

Key	
	red
	blue
	green
	purple
	orange
	yellow

3D Shapes

I Spy and Count to 10

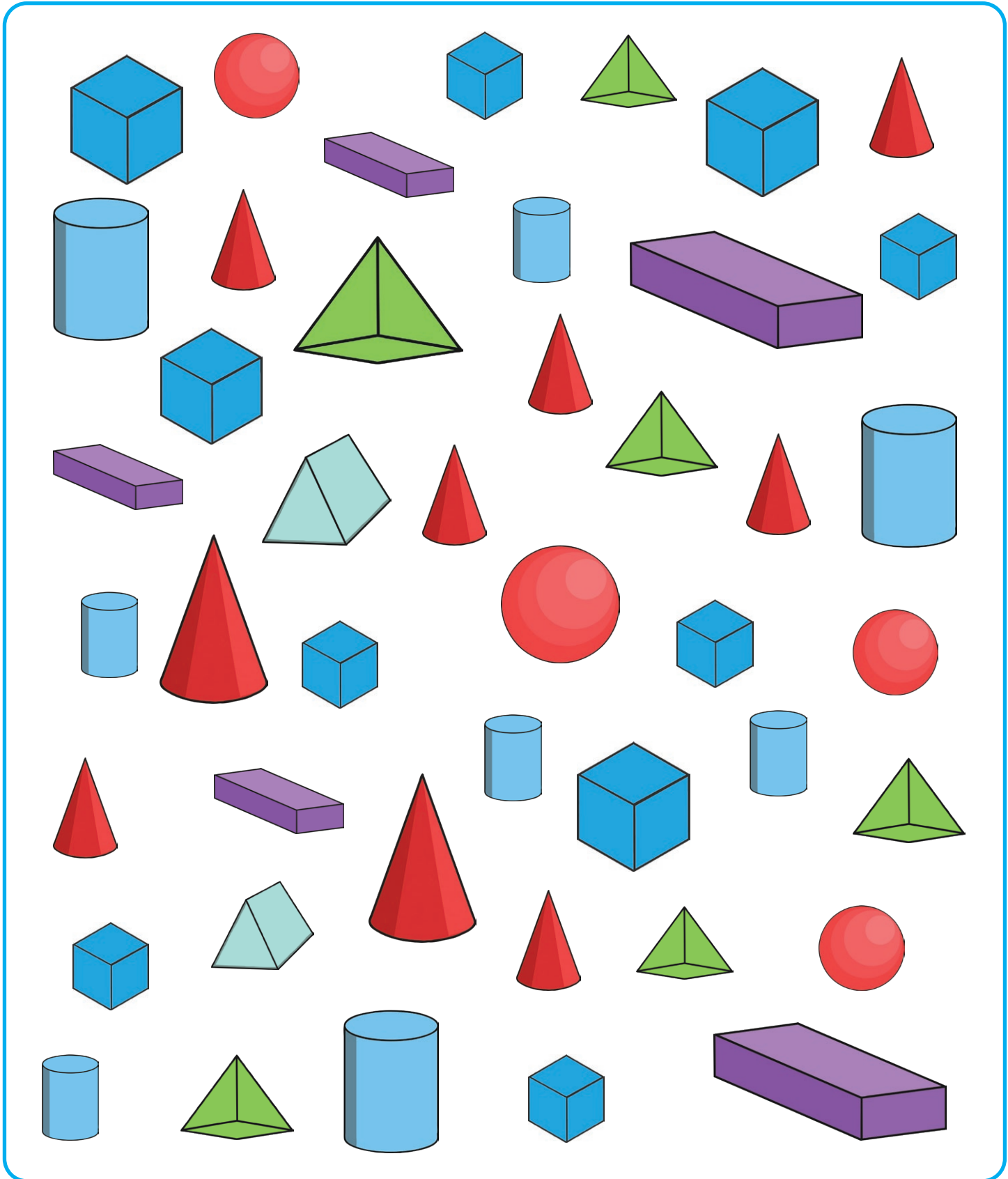

3D Shapes

I Spy and Count to 10 Checklist

Count the number of each type of 3D shape and write the numeral in the box.

cubes

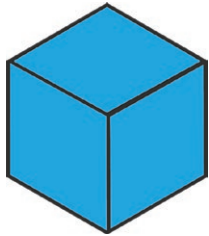

spheres

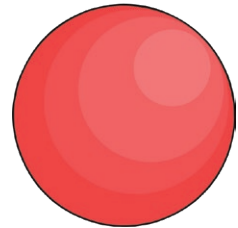

cuboids

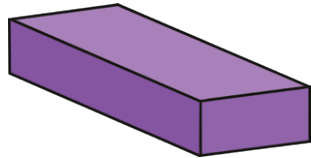

triangular
prisms

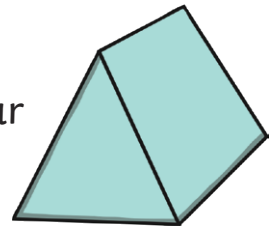

cylinders

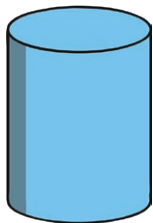

pyramids

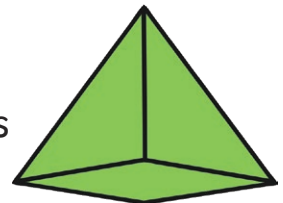

cones

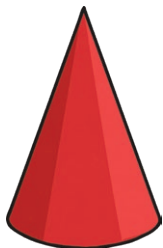

3D Shape Names

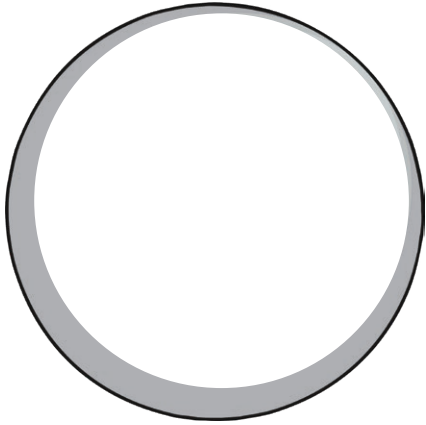

sphere

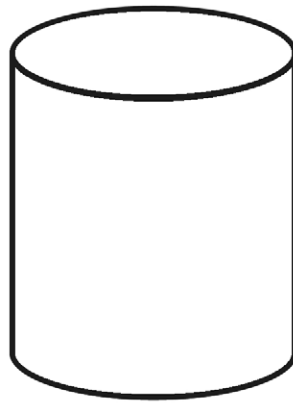

cylinder

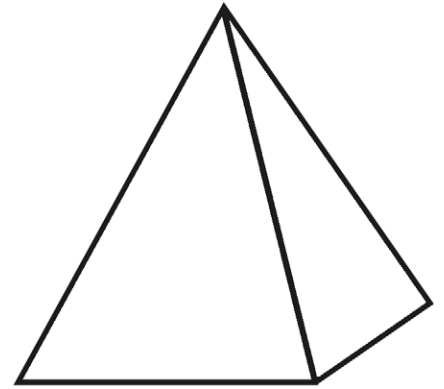

pyramid

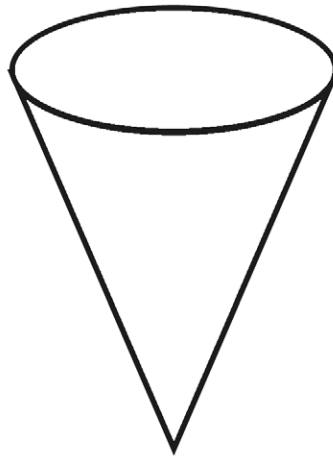

cone

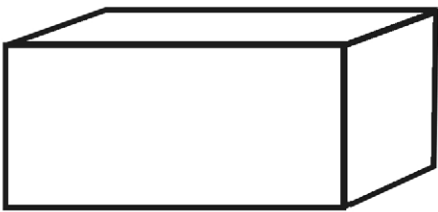

cuboid

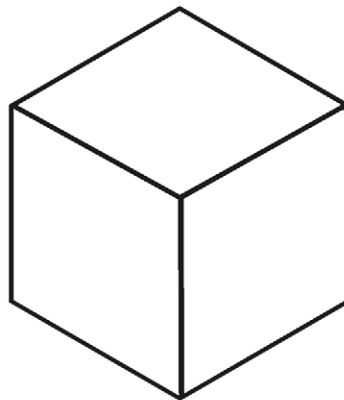

cube

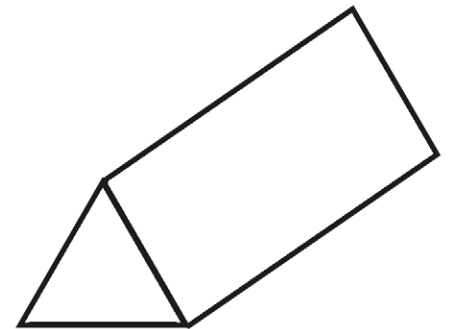

**triangular
prism**

Cube Shape

Cube

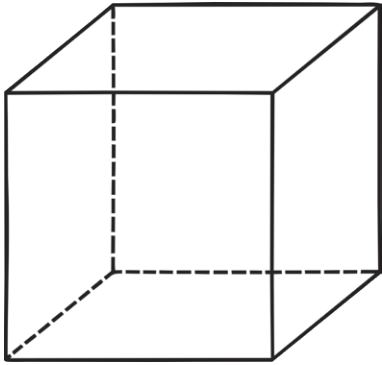

Trace

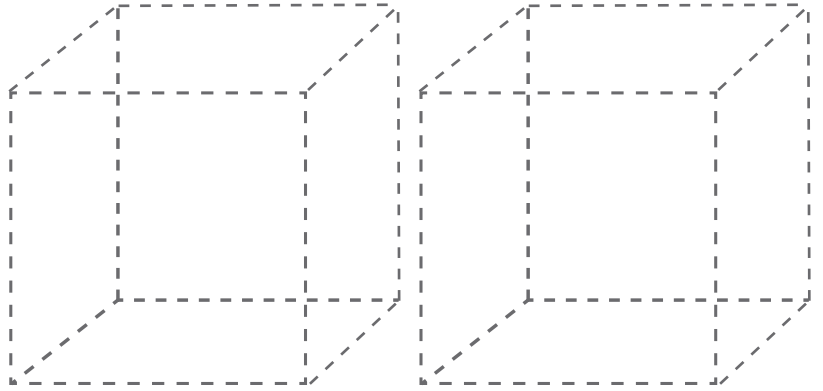

Colour in

CUBE

Stick the cubes in the correct size order.

Colour in all the cubes.

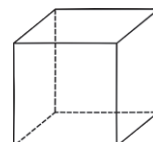
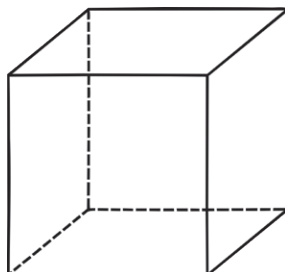
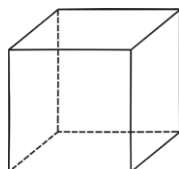
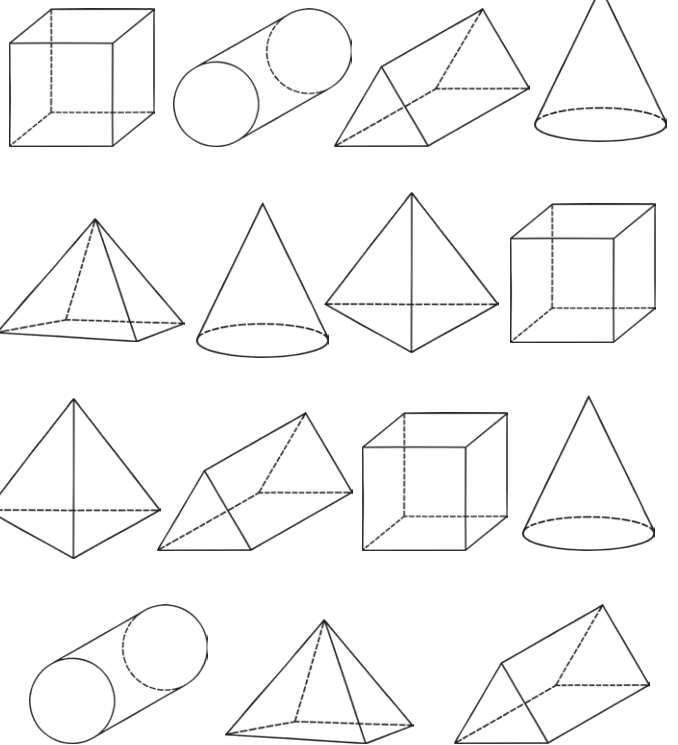

Cylinder Shape

Cylinder

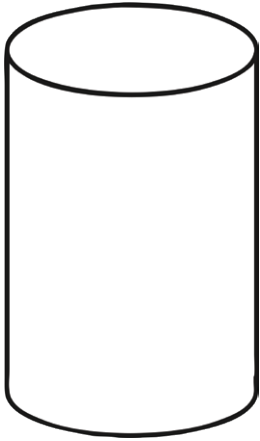

Trace

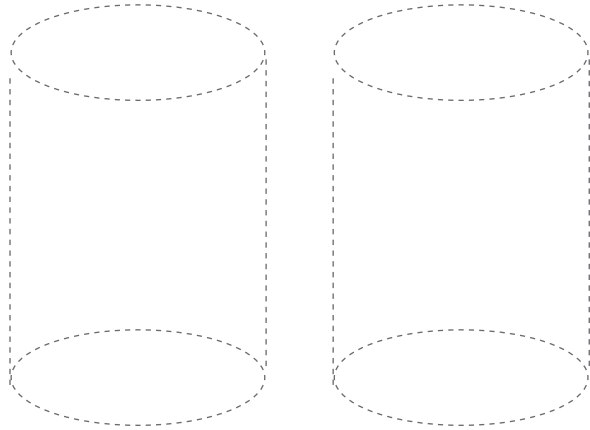

Colour in

CYLINDER

Stick the cylinders in the correct size order.

Colour in all the cylinders

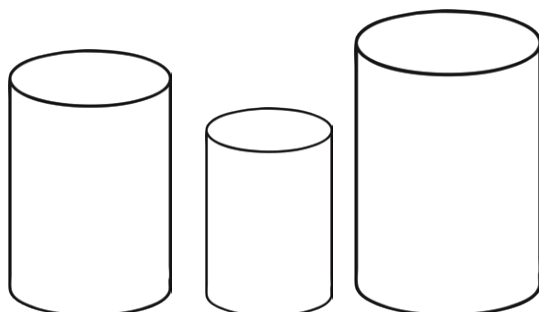
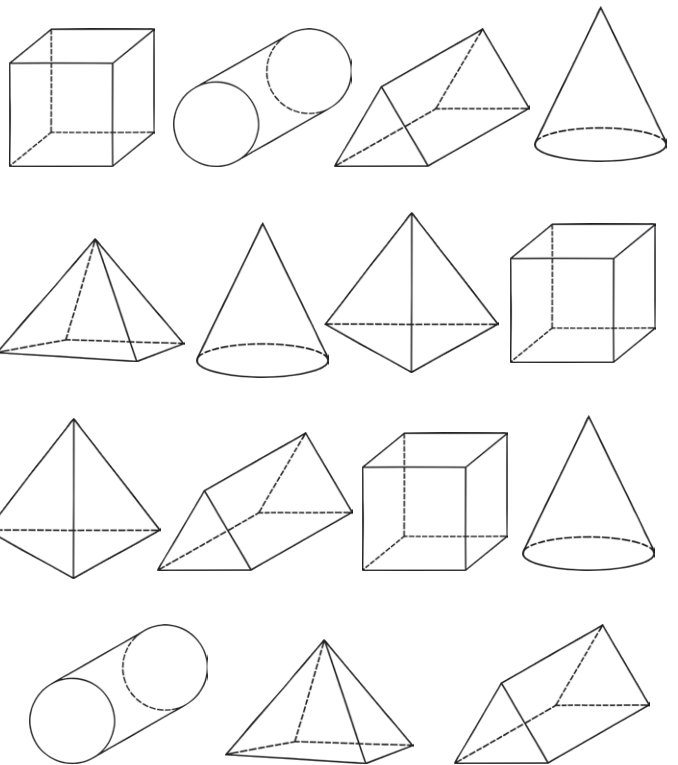

Cone Shape

Cone

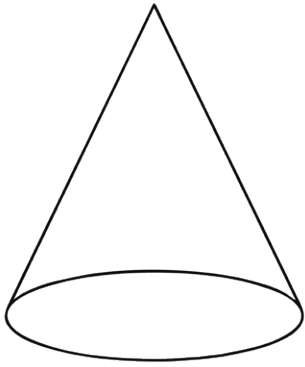

Trace

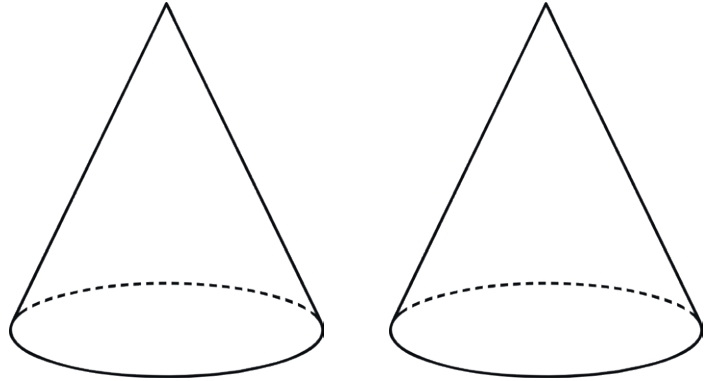

Colour in

CONE

Colour in all the cones.

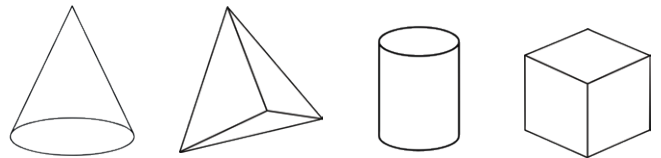
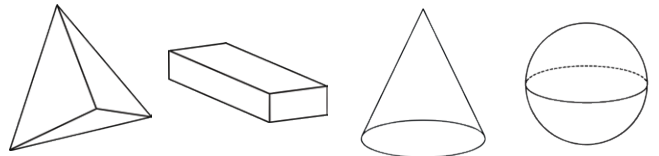
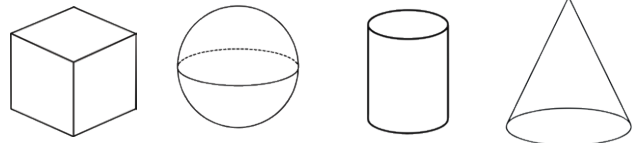
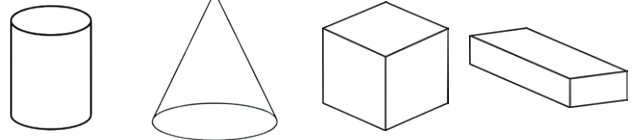

Stick the cones in the correct size order.

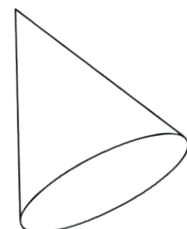
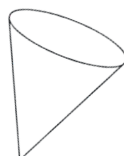
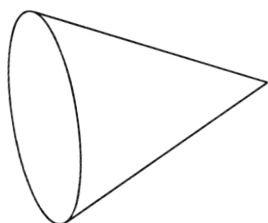

Sphere Shape

Sphere

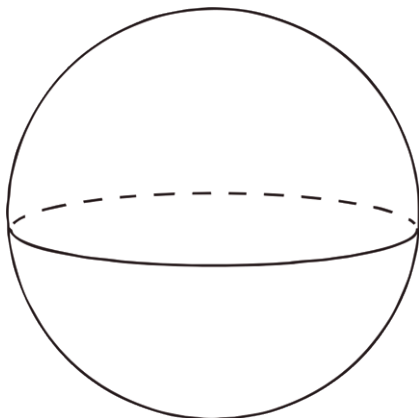

Trace

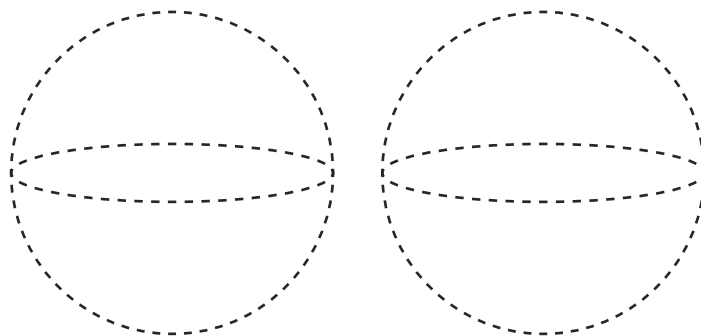

Colour in

SPHERE

Colour in all the spheres.

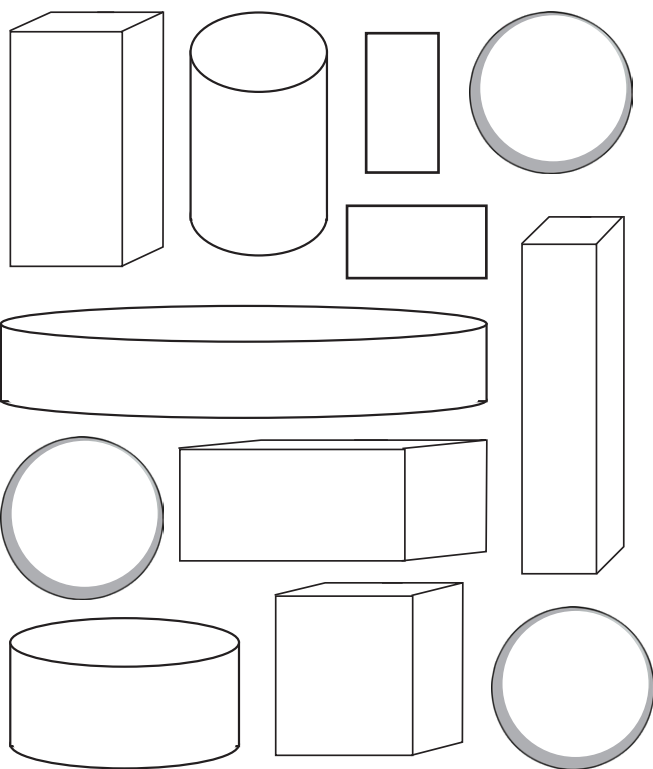

Stick the spheres in the correct size order.

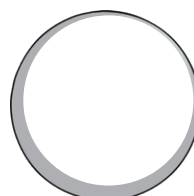
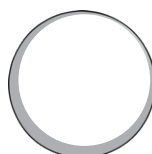
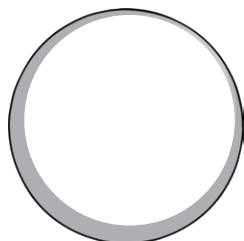

Cuboid Shape

Cuboid

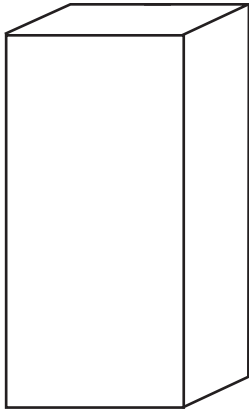

Trace

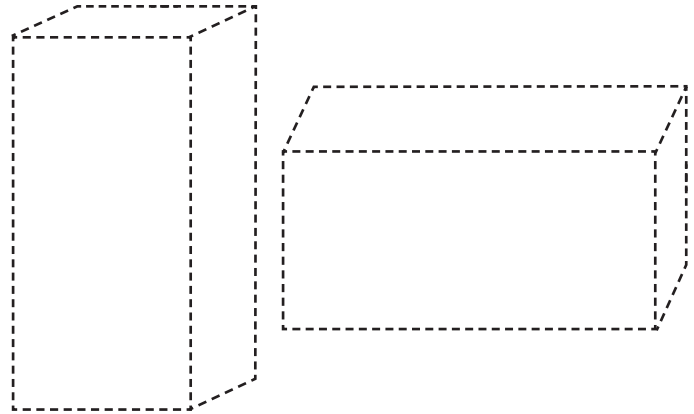

Colour in

CUBOID

Stick the cuboids in the correct size order.

Colour in all the cuboids.

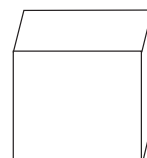
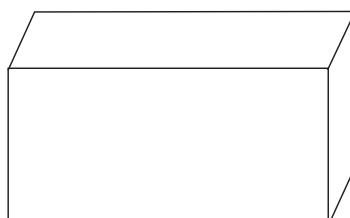
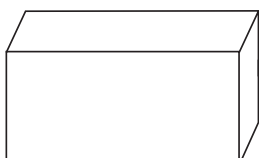
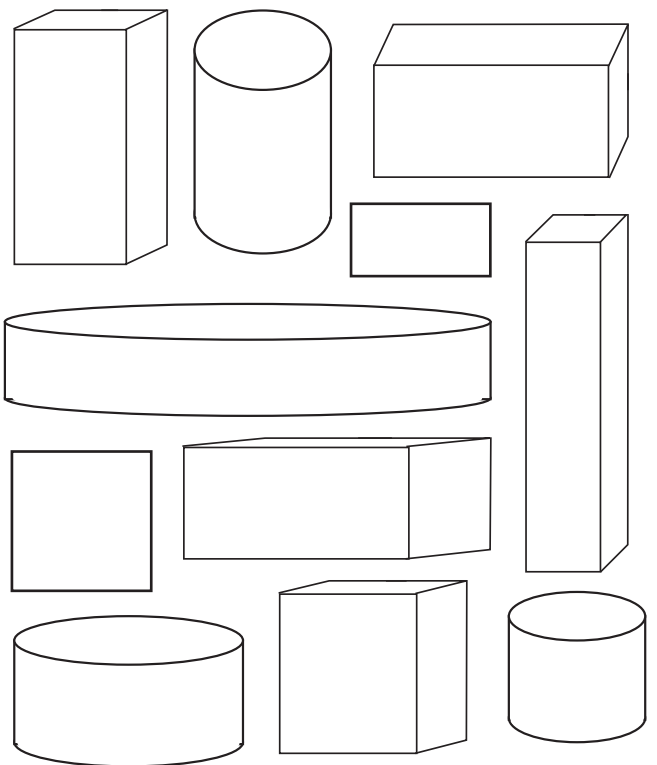

3D Shapes Colouring

Find the shapes and colour them in the correct colour.

Colour the cubes green.

Colour the spheres blue.

Colour the cones red.

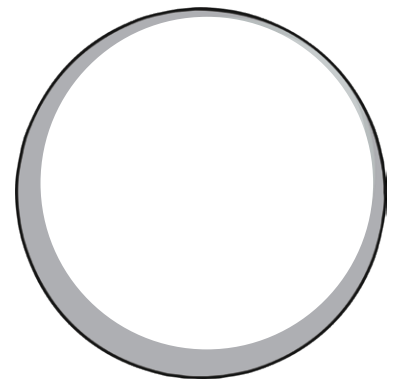
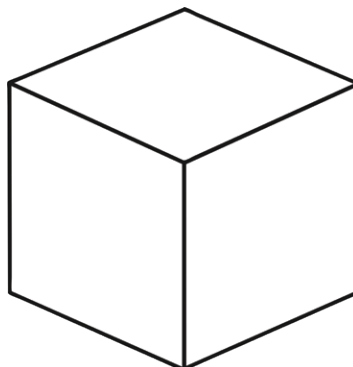
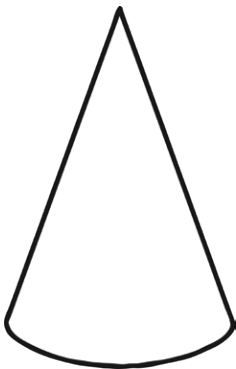
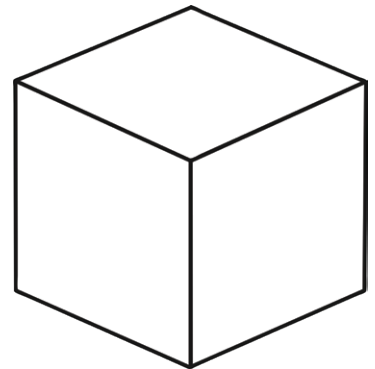
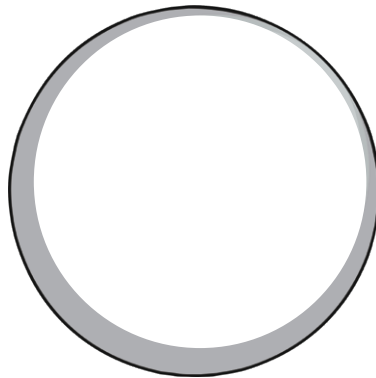
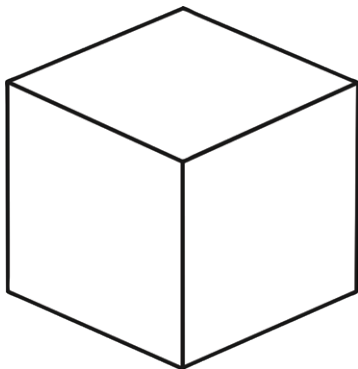
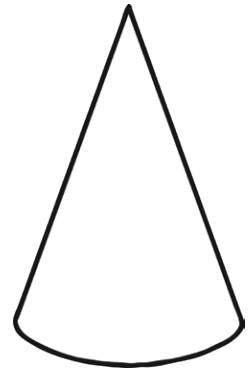
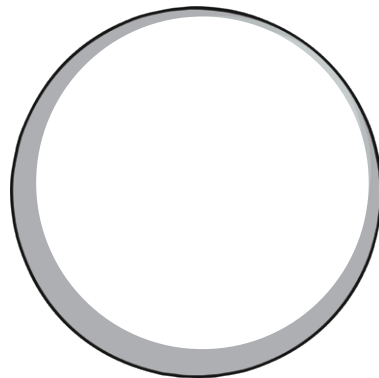
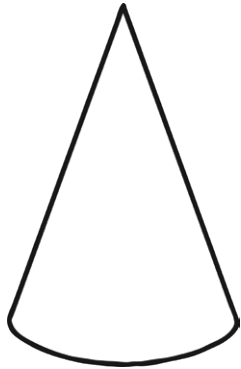

3D Shapes Colouring

Find the shapes and colour them in the correct colour.

Colour the cuboids green.

Colour the cylinders blue.

Colour the pyramids red.

