

Key Rules When Drawing a Bar Chart

We need:

BARS

LABELS

AXES

SCALE

TITLE

Bar Chart Showing the Number of Pets Each Student in a Year 7 Class Owned

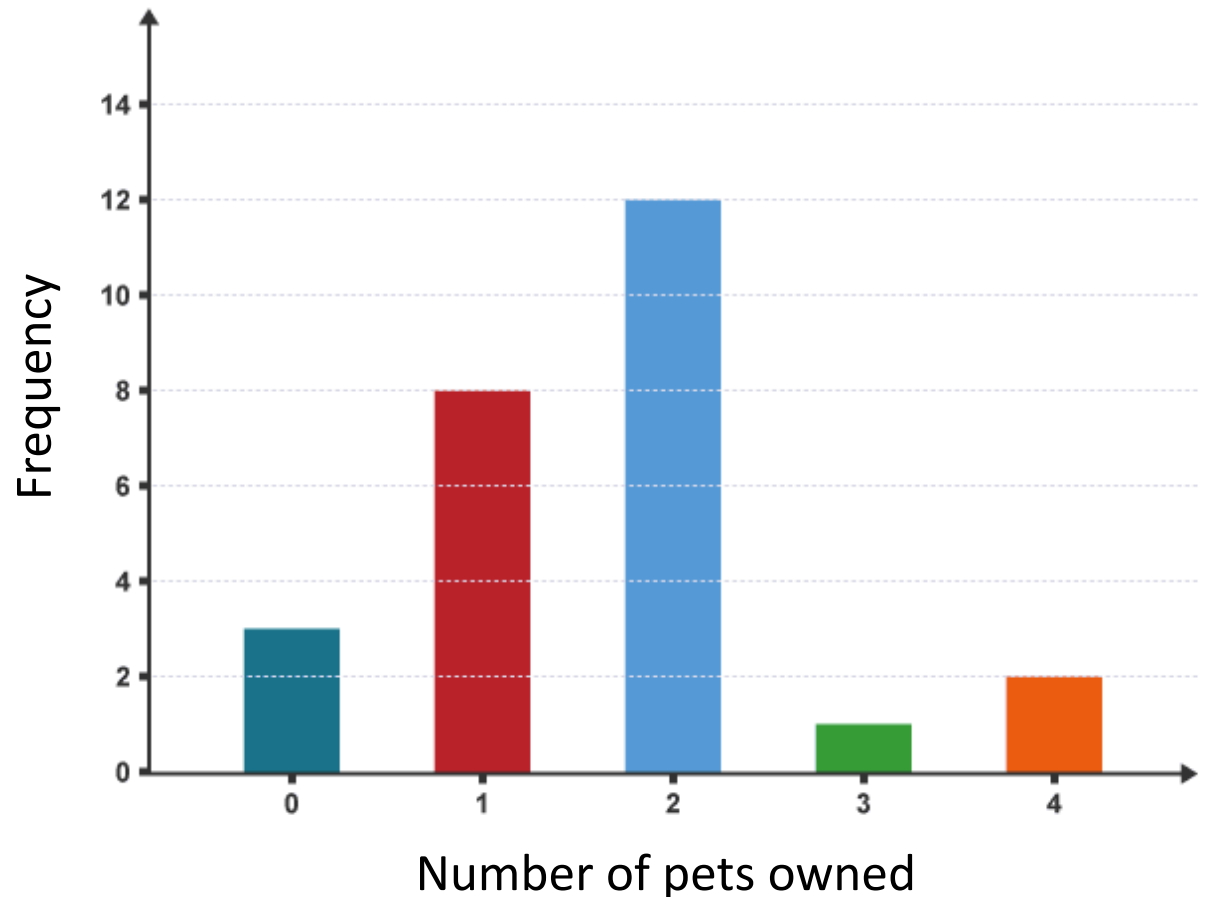

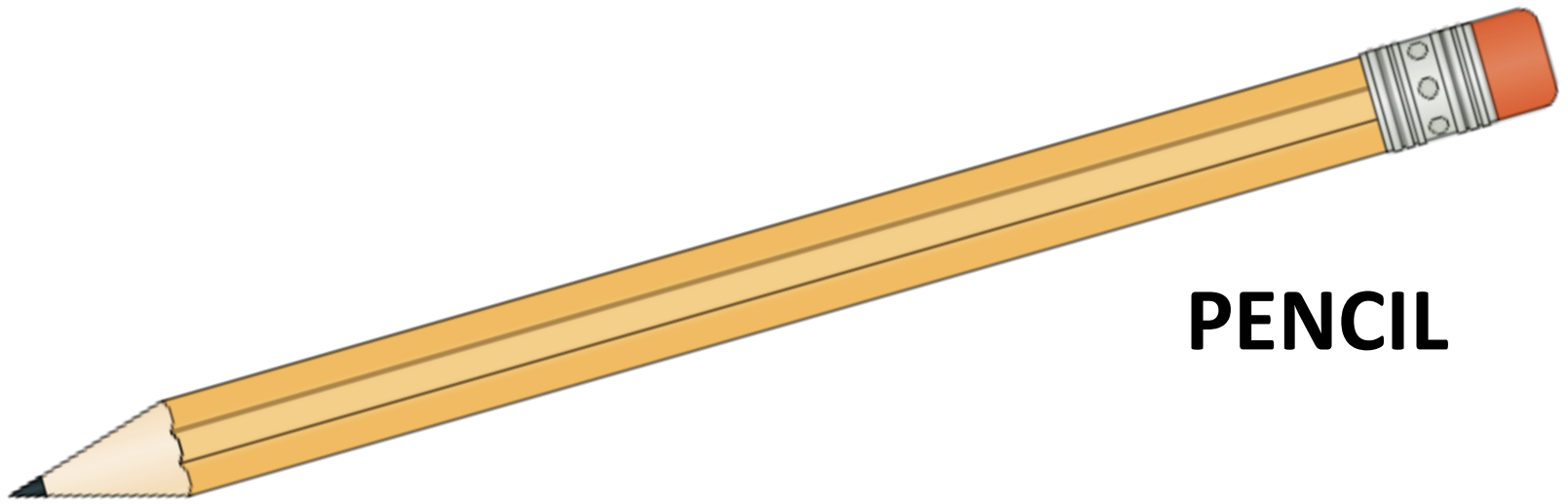

PENCIL

Equipment for drawing Bar Charts

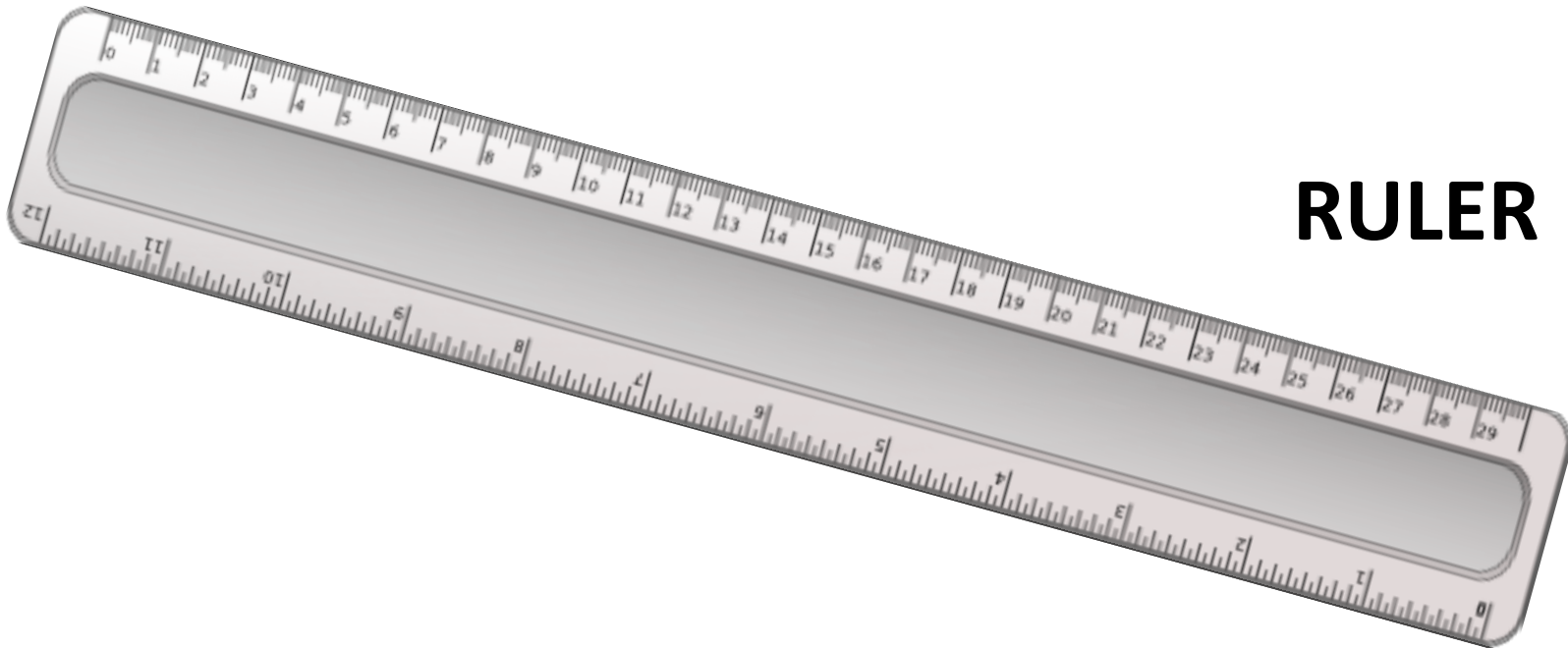

RULER

We looked at creating frequency tables from a list of data.

Type of Pet	Tally Marks	Frequency
Cat		7
Dog		12
Fish		9
Horse		3
Bird		5
Rabbit		4
Total		40

We can also display this information in a different way, using a **BAR CHART**.

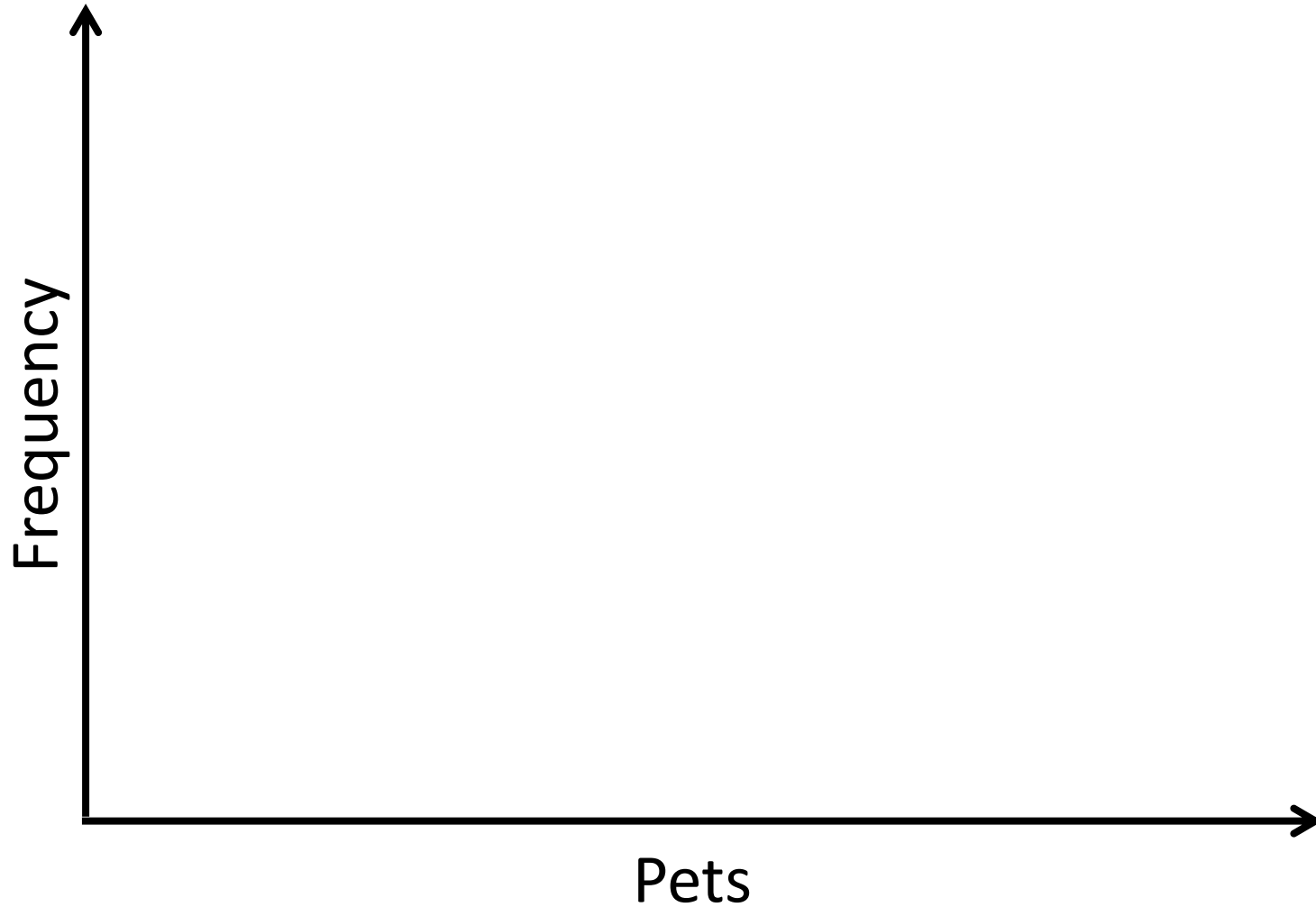

BARS

LABELS

AXES

SCALE

TITLE

Bar Chart Showing the Number of Pets Owned by a Group of Children

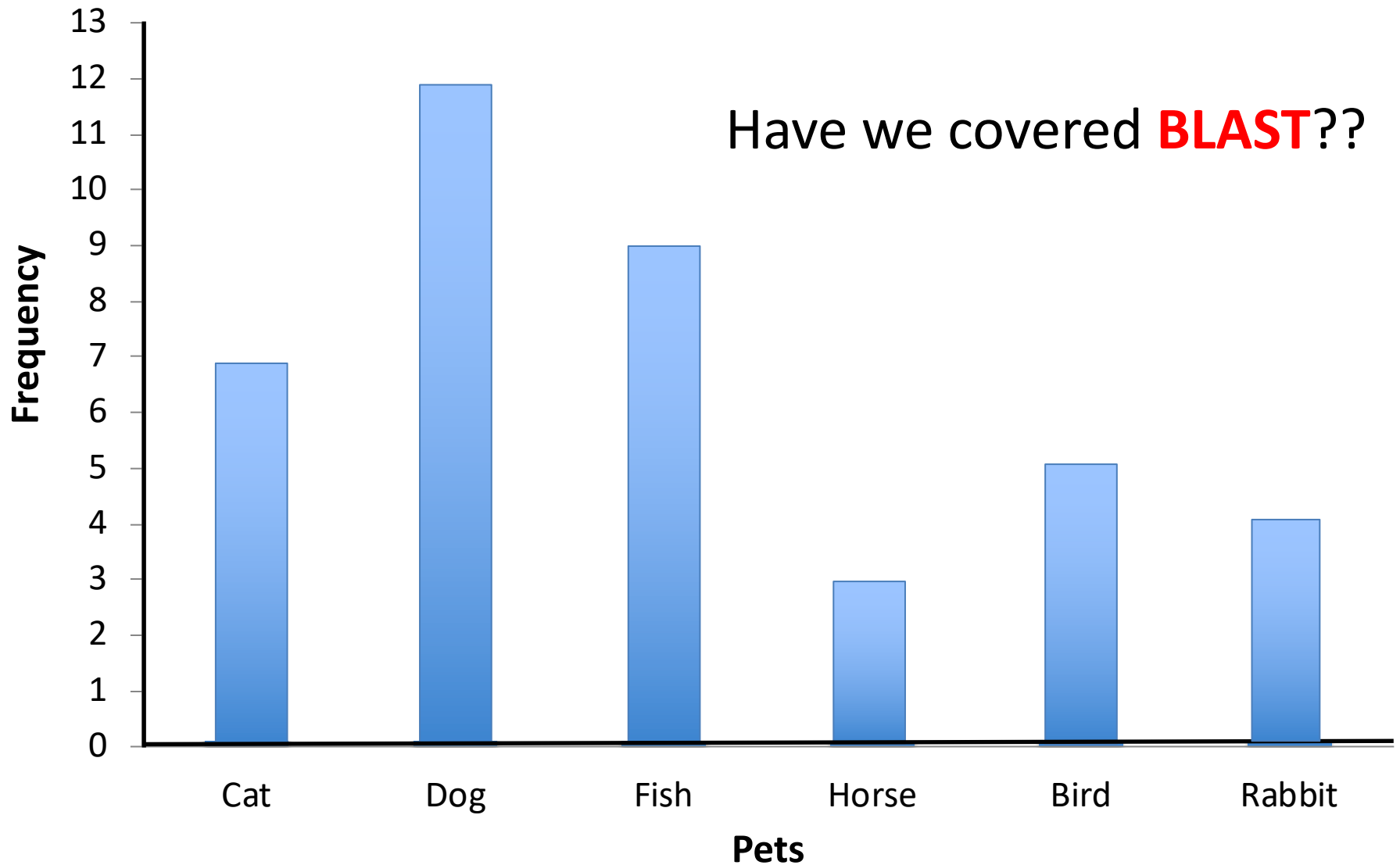

Bar Charts - Gaps

The type of data we draw a bar chart for is:

Discrete Data

This type of data has distinct values. Only particular values are possible. We use gaps to show each group is separate.

Can you think of any more examples of discrete data?

Bar Chart Showing the Number of Pets Each Student in a Year 7 Class Owned

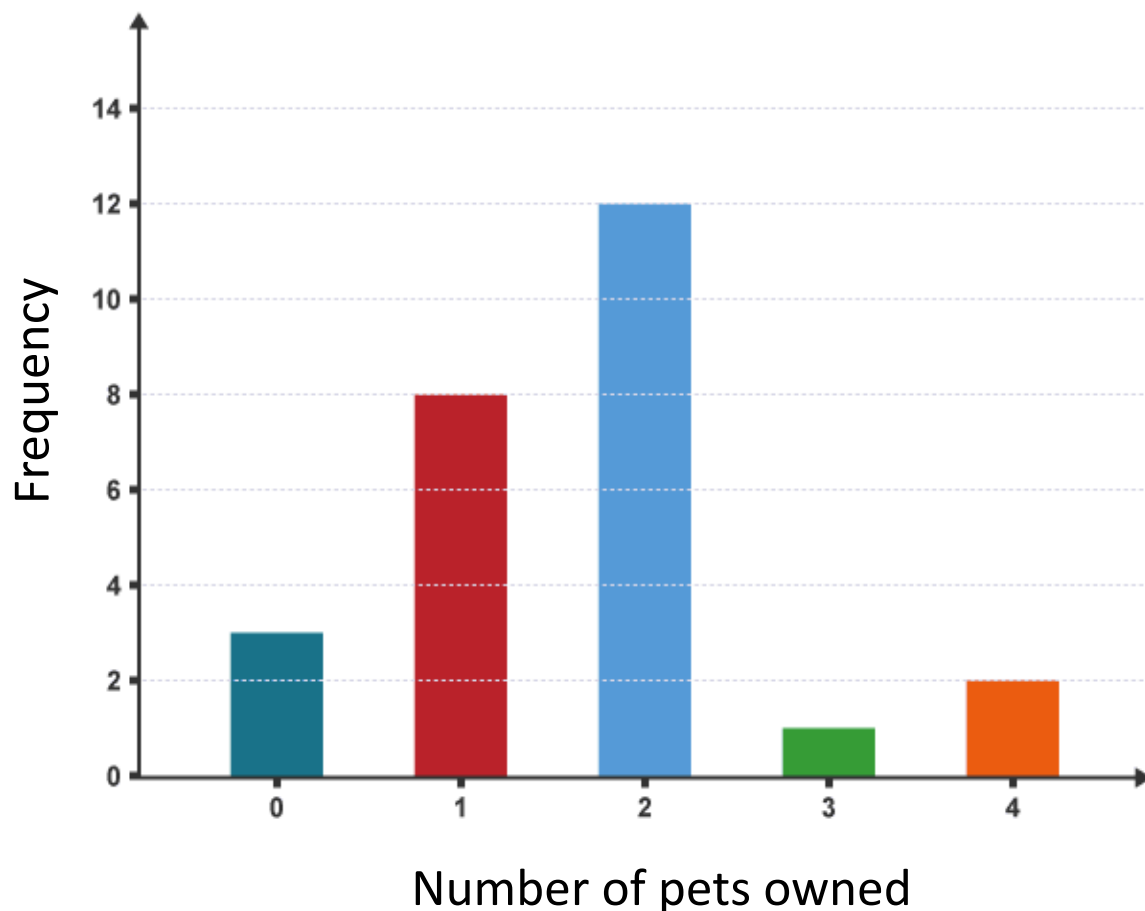

Draw your own Bar Chart Worksheet

1) Favourite Pet	snake	dog	fish	cat	bird
Frequency	5	7	10	4	3

People's favourite Pets

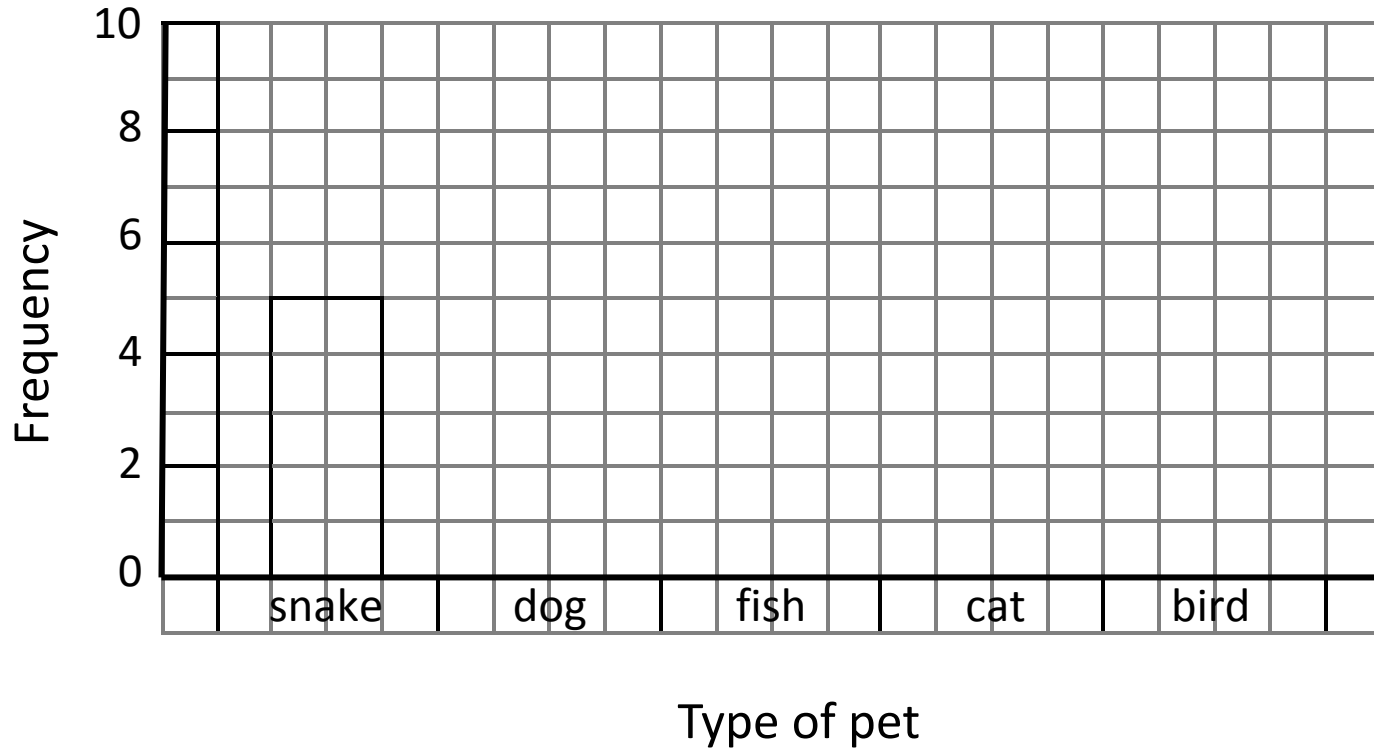

2)

Favourite Subject	English	Maths	PE	French	History
Frequency	9	13	8	2	10

Draw the bar chart on the grid below.

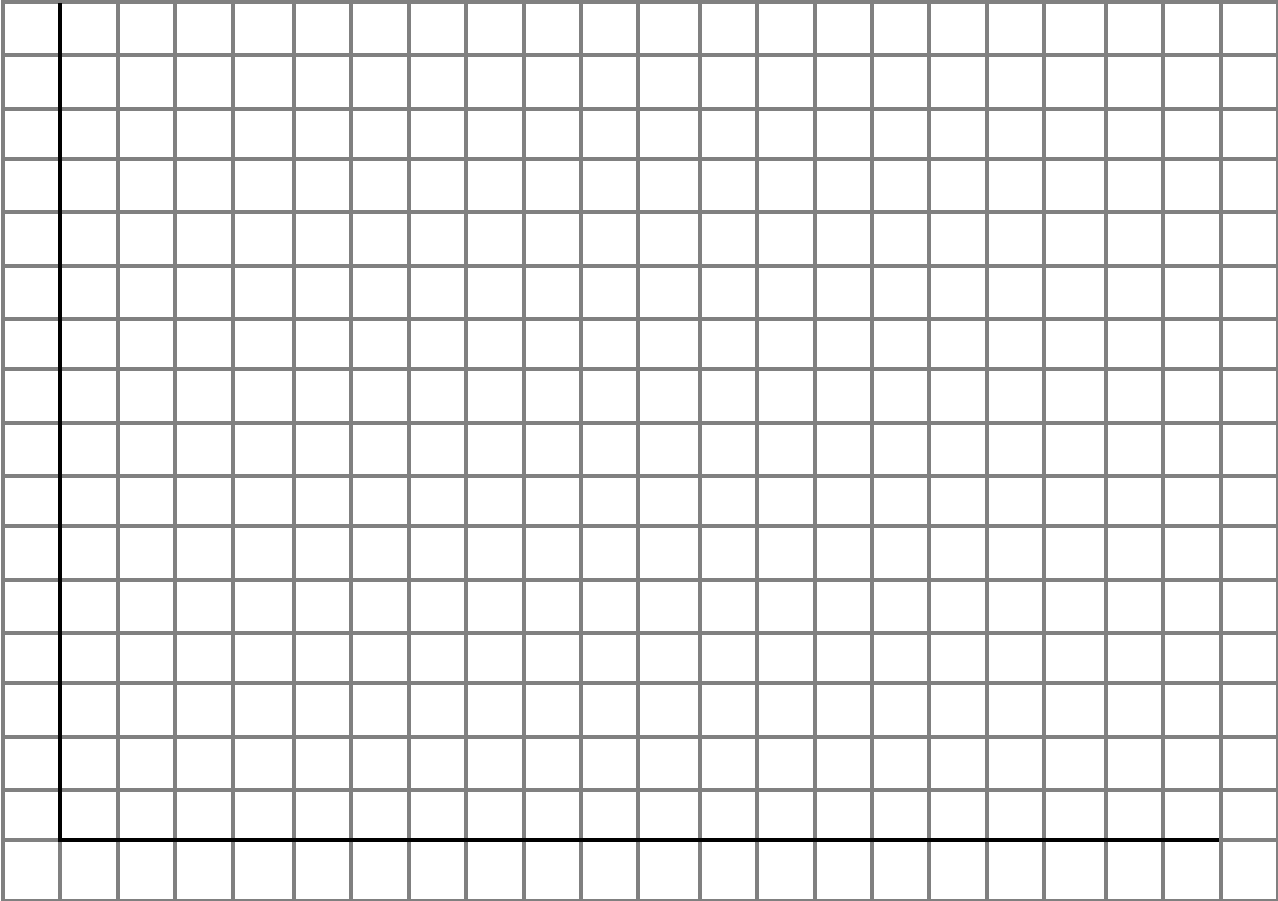

2) Favourite Subject	English	Maths	PE	French	History
Frequency	9	13	8	2	10

Draw the bar chart on the grid below.

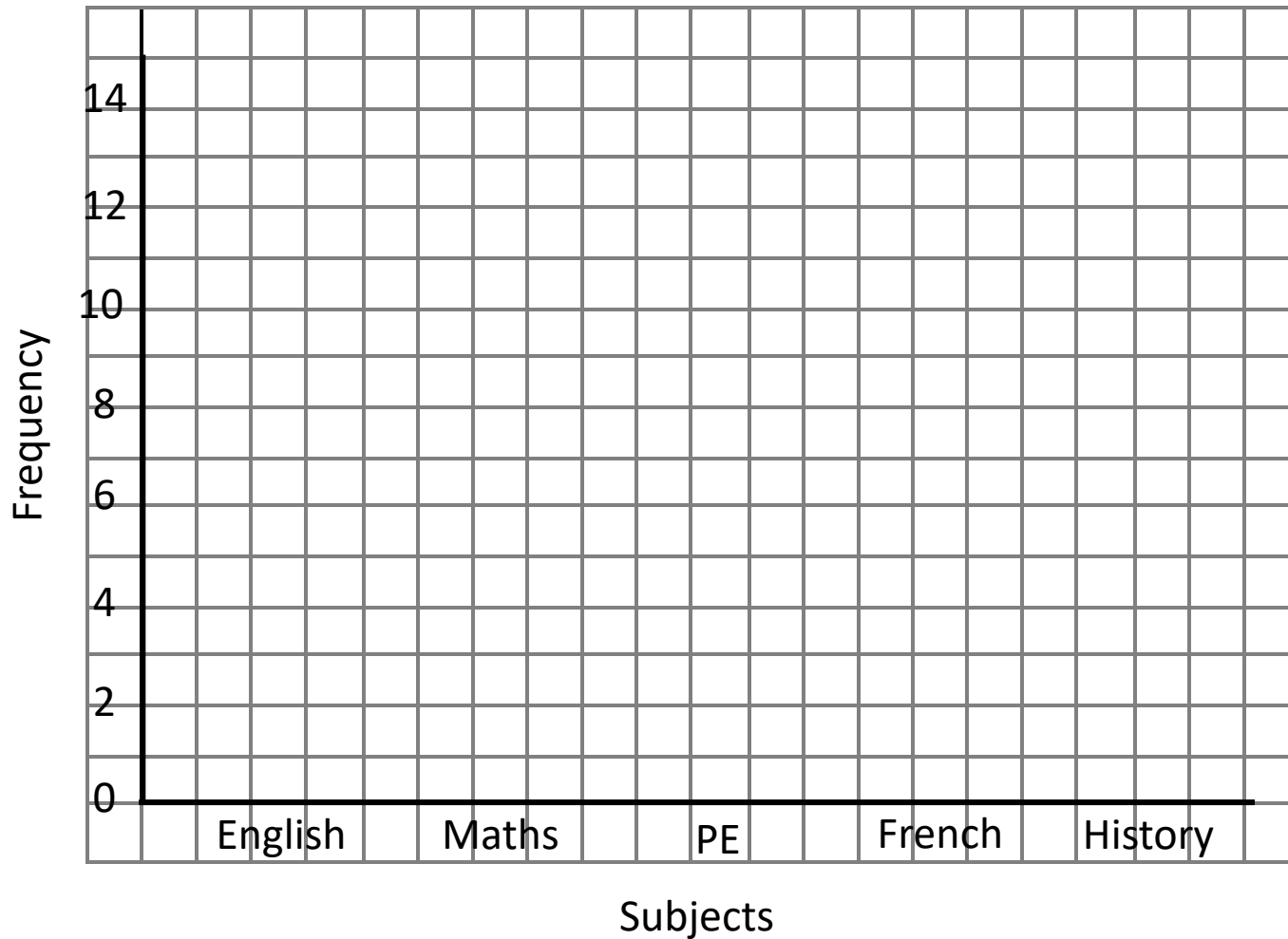

Draw your own Bar Chart Worksheet

1)

Favourite Pet	snake	dog	fish	cat	bird
Frequency	5	7	10	4	3

Bar chart showing people's favourite Pets

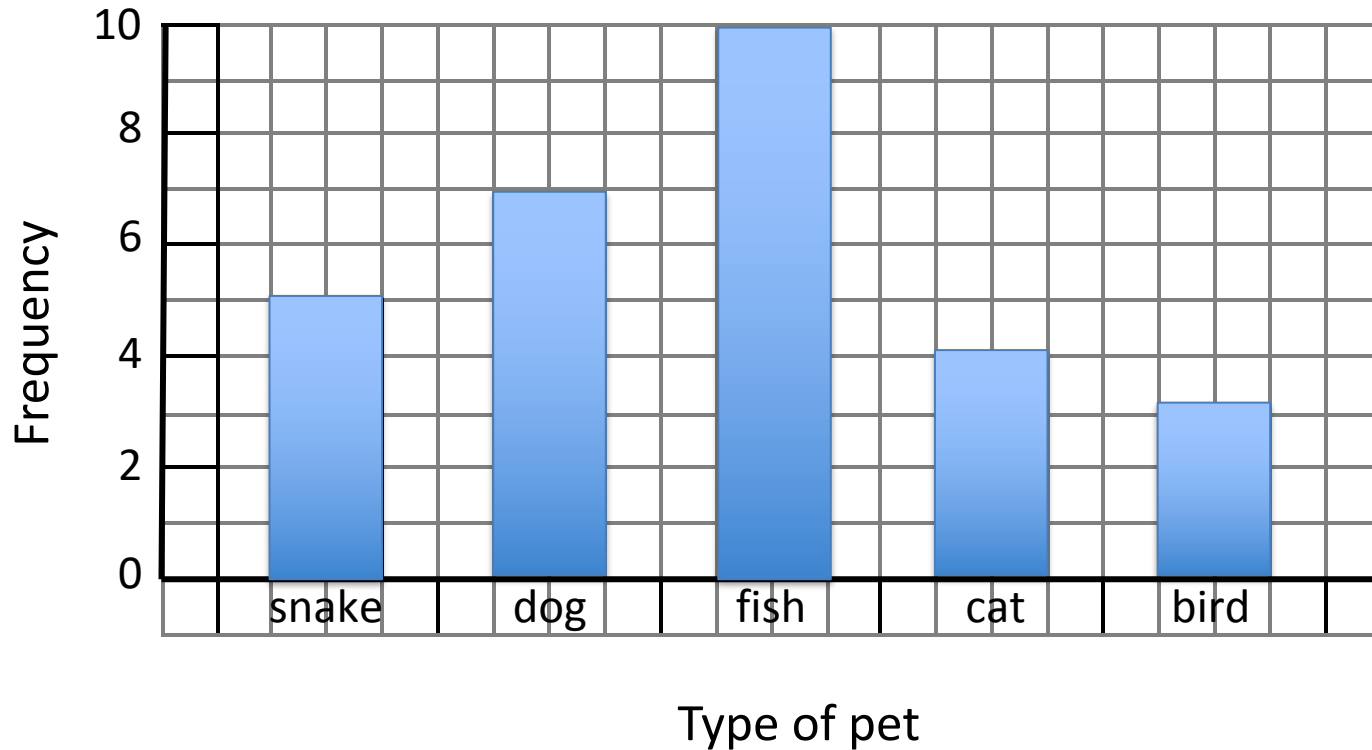

2) Favourite Subject

Favourite Subject	English	Maths	PE	French	History
Frequency	9	13	8	2	10

Bar chart showing a group of students favourite subject

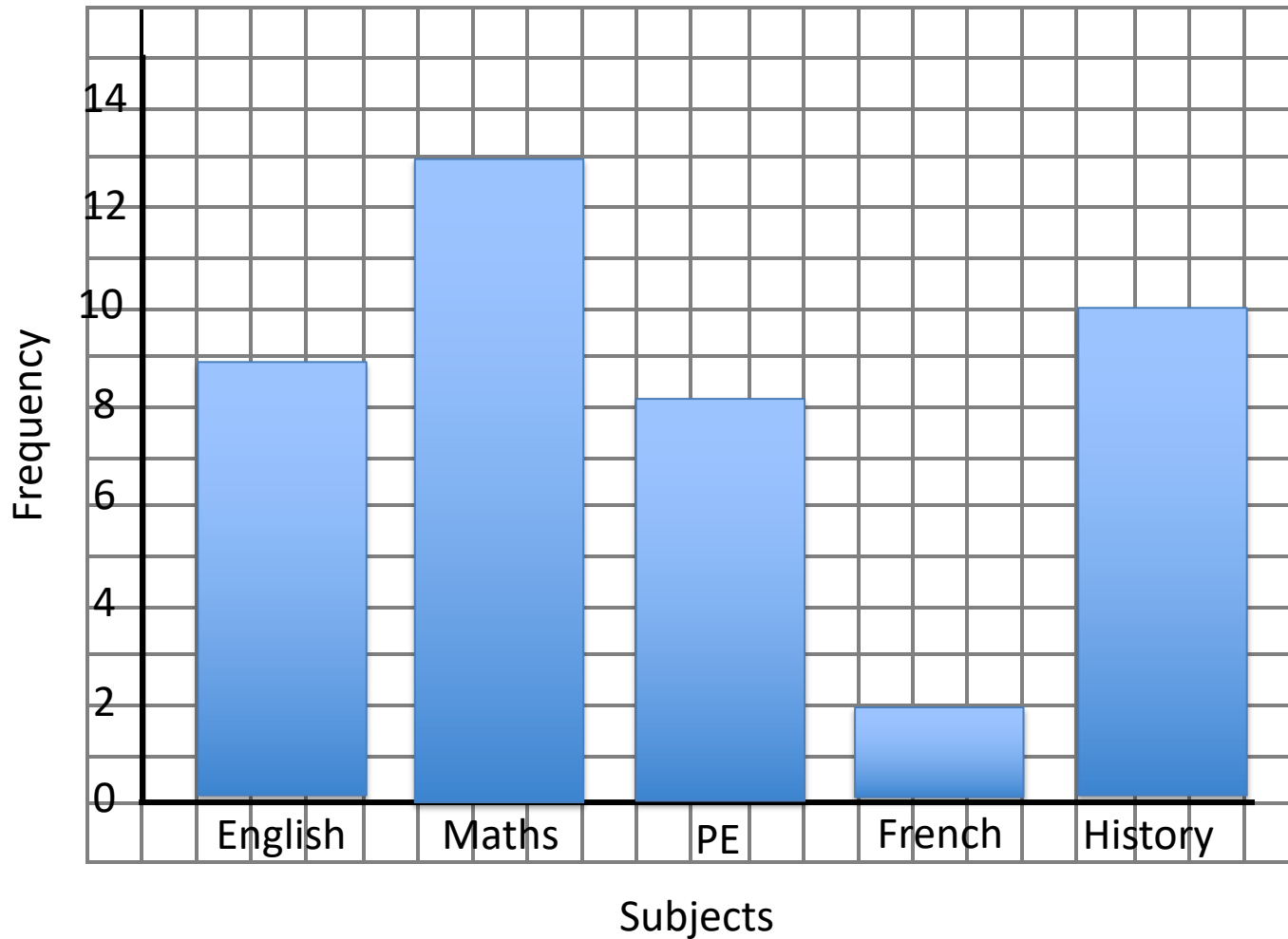

Key Rules when Drawing a Bar Chart

We need:

BARS

LABELS

AXES

SCALE

TITLE

Bar Chart Showing the Number of Pets Each Student in a Year 7 Class Owned

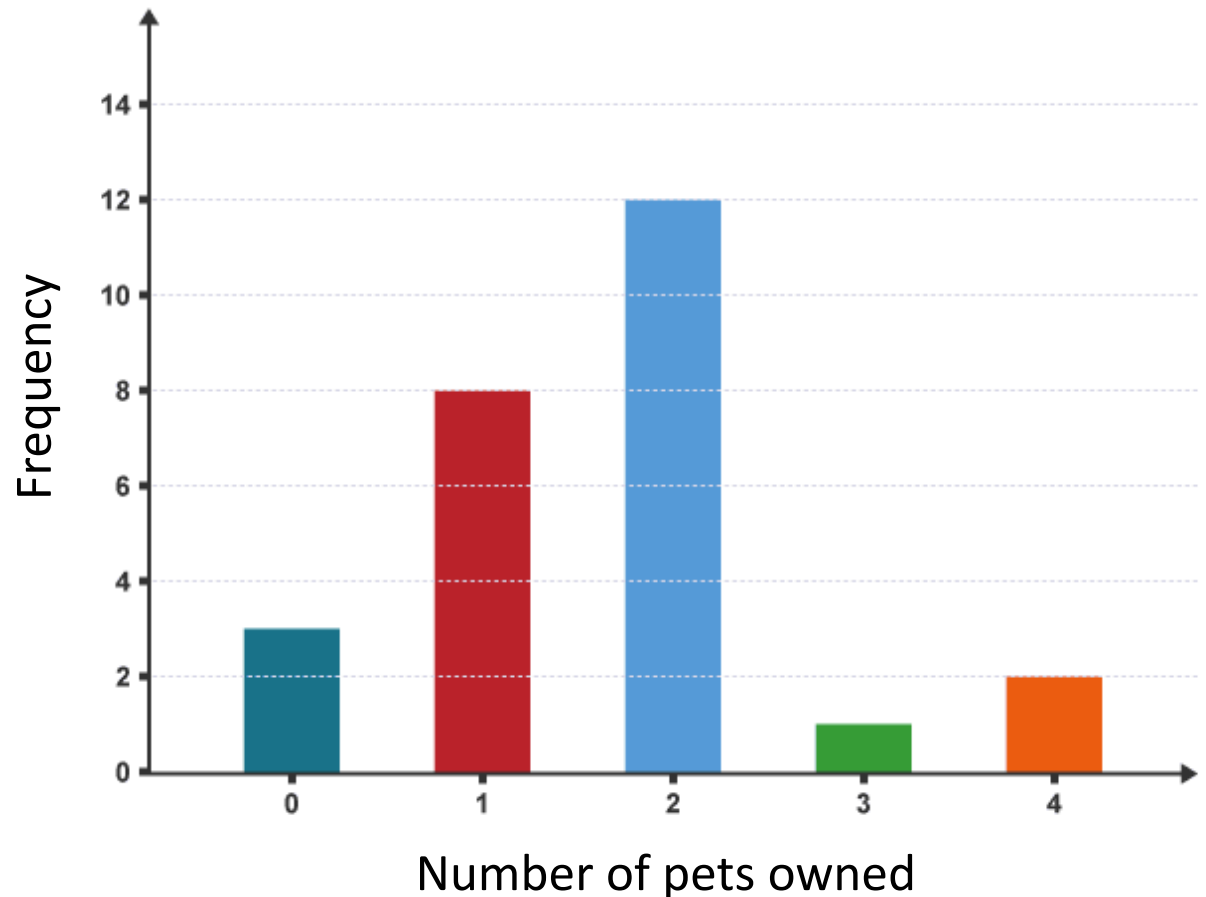

Good Bar Chart? Bad Bar Chart?



Its time to **test your knowledge** of drawing graphs to pick out what is missing from the Bar charts I will show you.

On your whiteboards, use **BLAST** to help you and write down anything that is missing. (There could be more than one thing).



A Graph to Show the Pets that Pupils Own

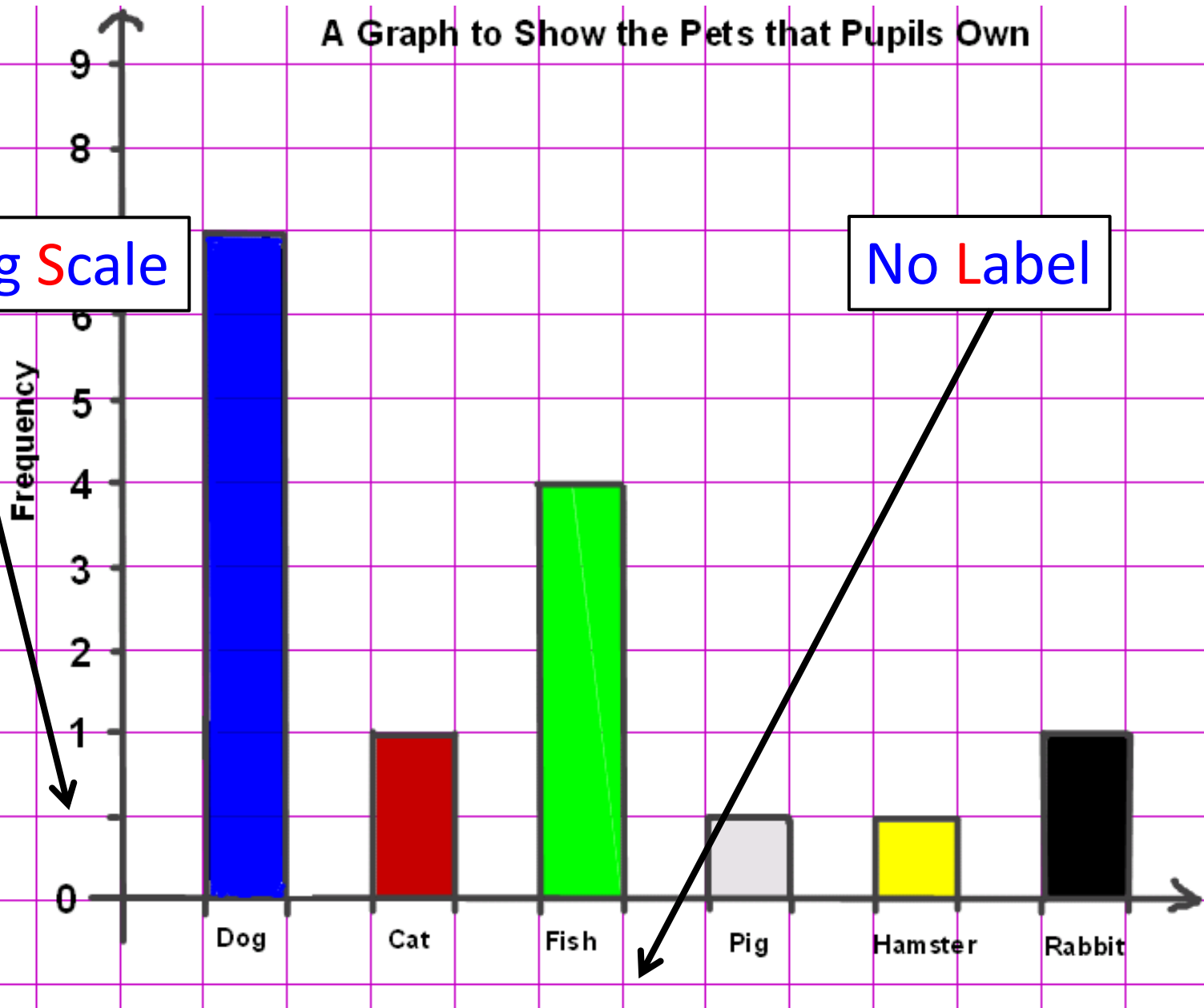

Missing Scale

No Label

No Label

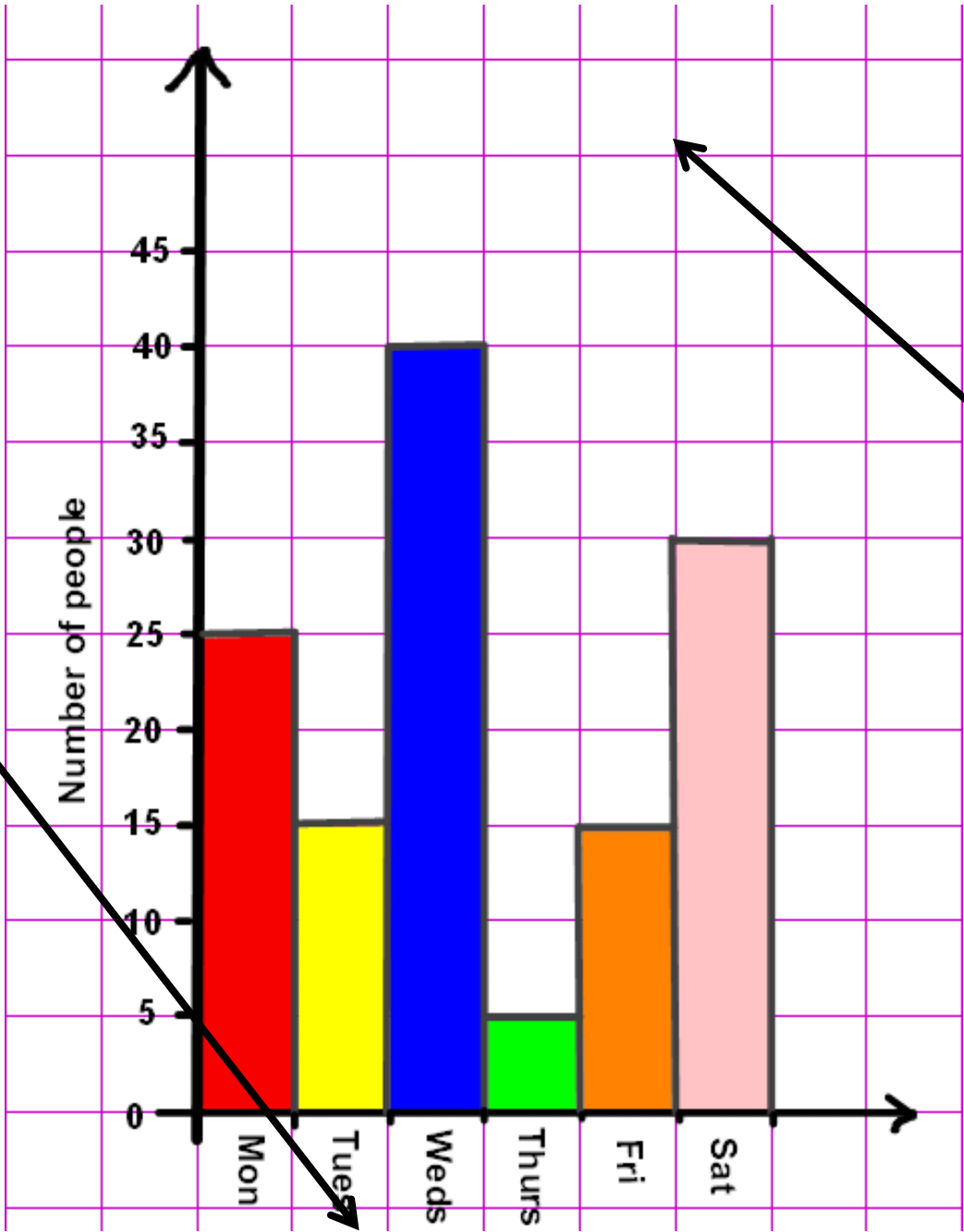

No Title

A Graph to Show Visitors to a Cafe

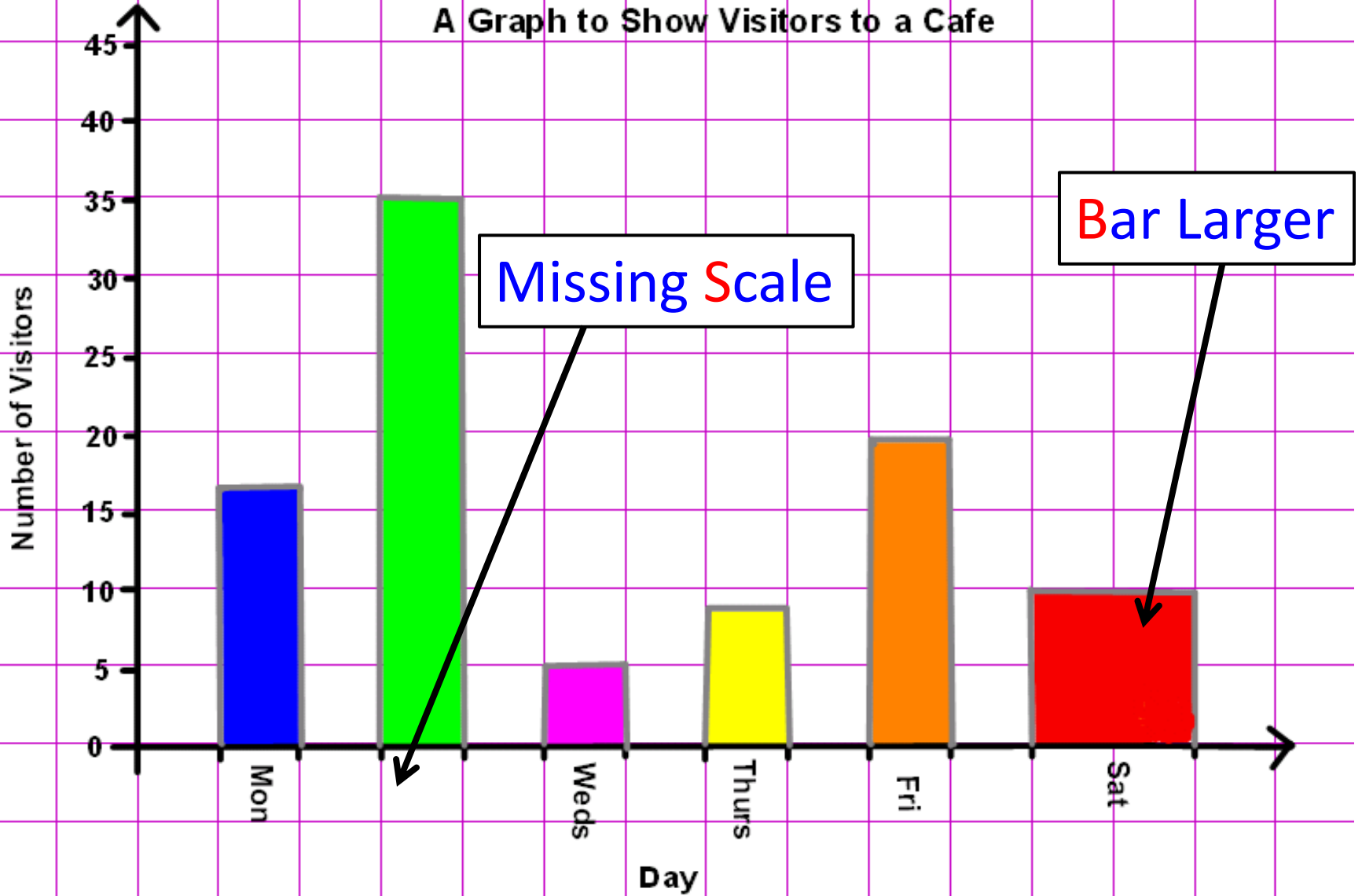

A Graph to Show the Colour of Cars Passing School

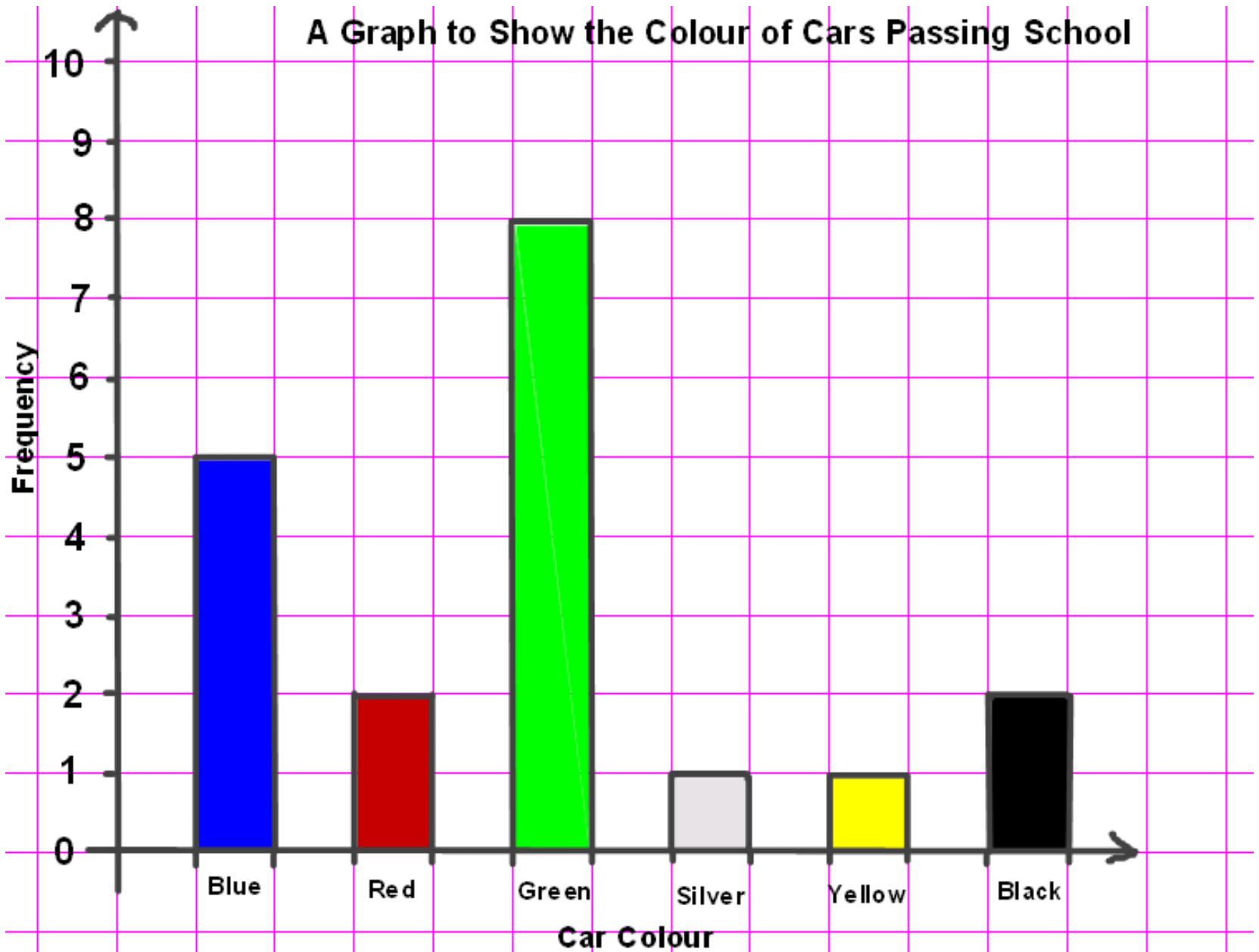

We need:

BARS

LABELS

AXES

SCALE

TITLE

Bar Chart Showing the Number of Pets Each Student in a Year 7 Class Owned

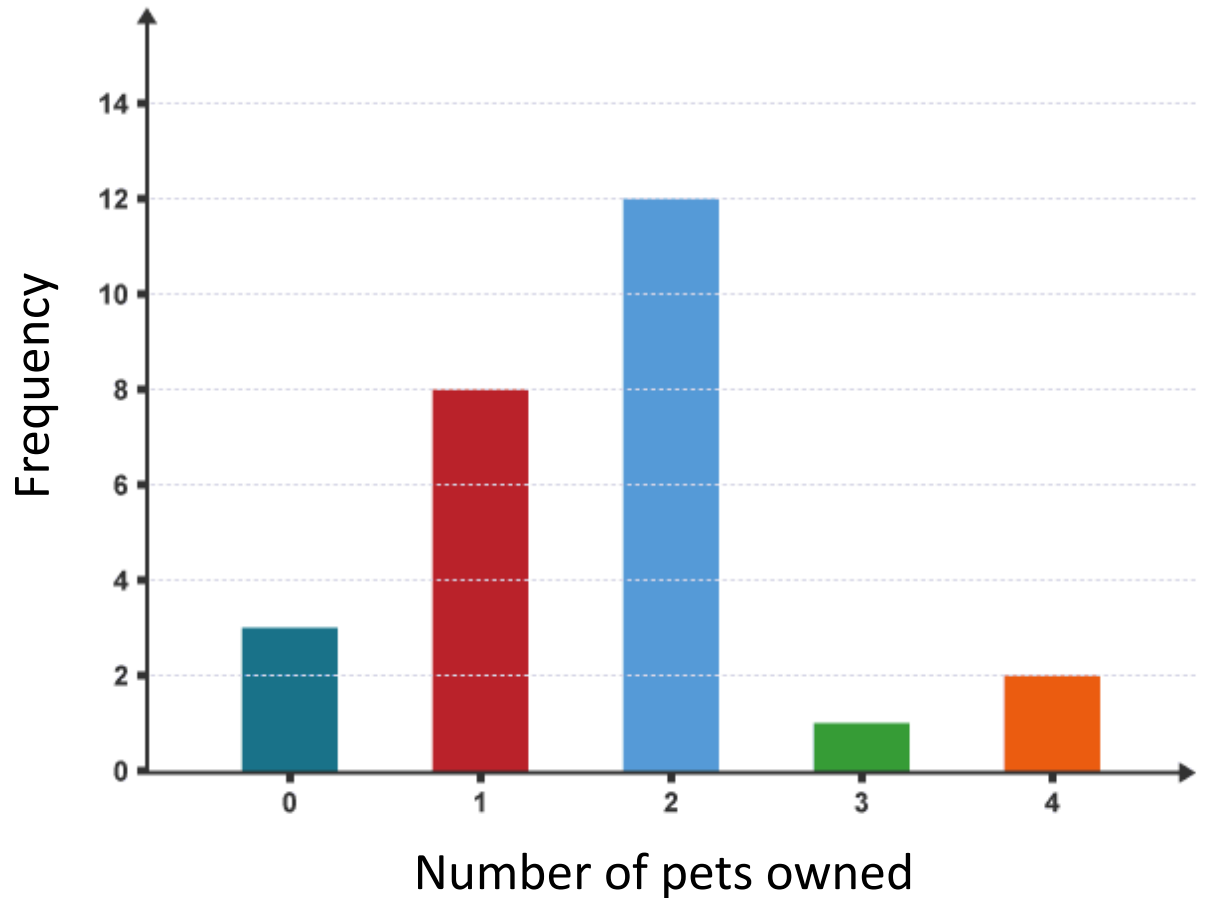

Introduction to a Similar Chart

Bar line Chart

It follows similar rules to a bar chart:

LABELS

AXES

SCALE

TITLE

What do you think is the difference?



So, can a Bar Line Chart display the same information as a Bar Chart?

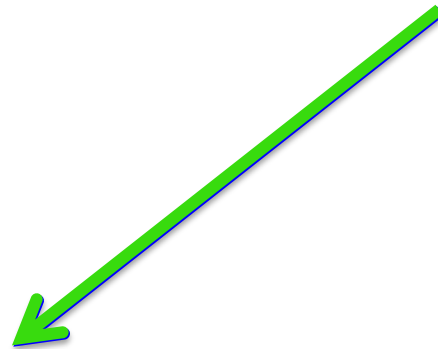

Drawing a Bar Line Chart

1) Favourite Pet

Favourite Pet	snake	dog	fish	cat	bird
Frequency	5	7	10	4	3

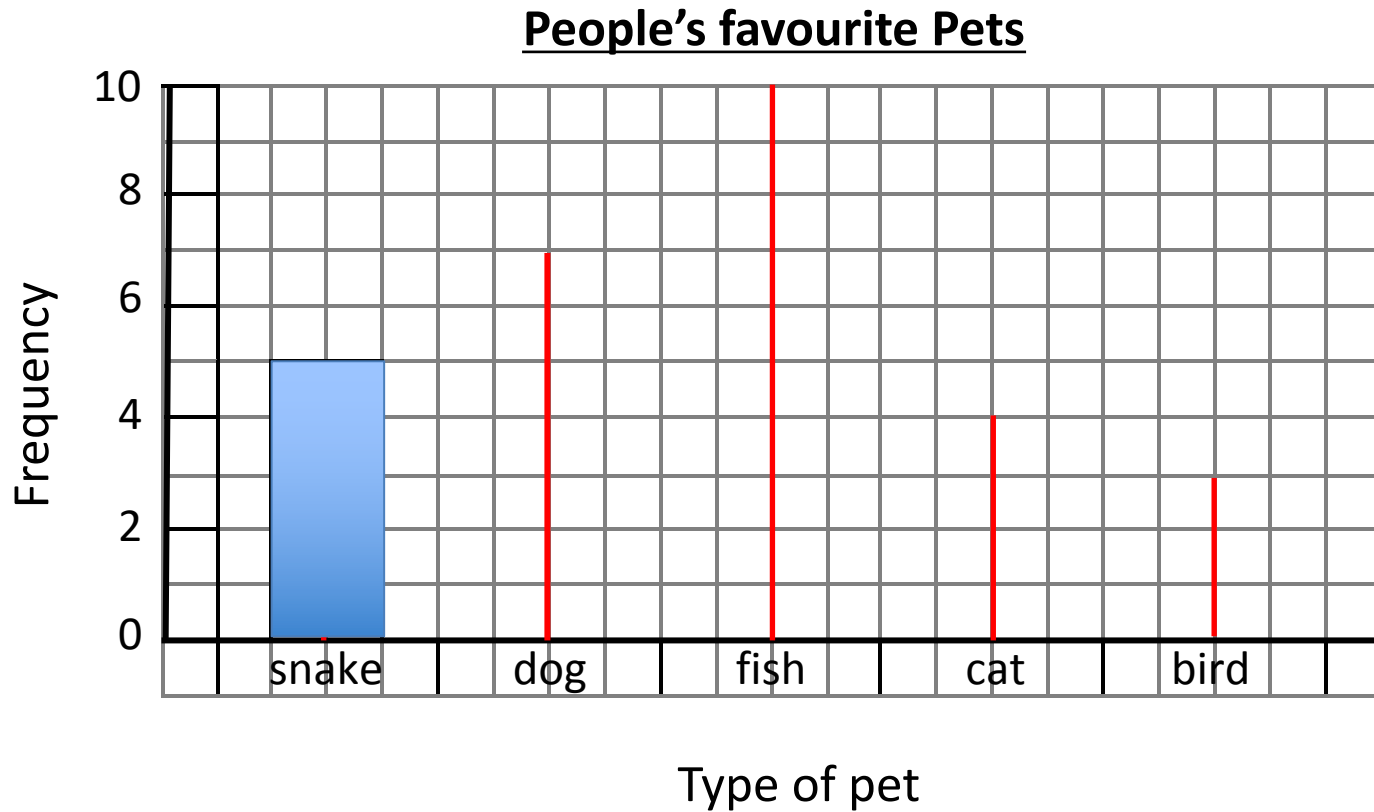

Worksheet

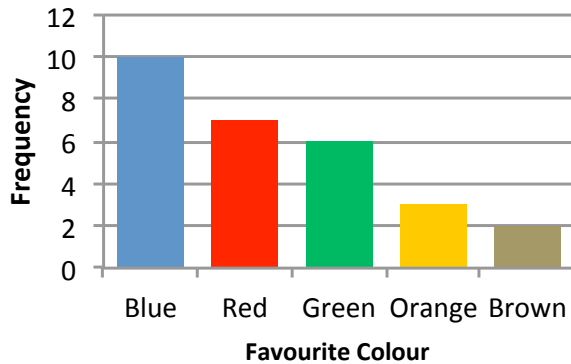

What is the most popular favourite colour? **Blue**

How many people chose it? **10 people**

How many people did NOT say green?
Total people = 10 + 7 + 6 + 3 + 2 = 28
28 - 6 = 22

Number of adults

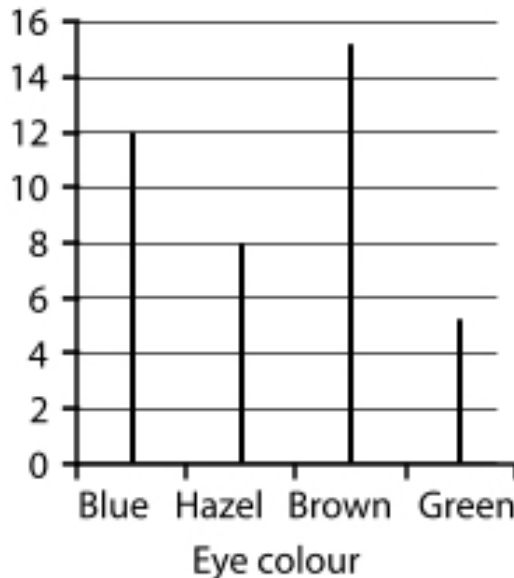

Fill in the blanks of the frequency table below to match the information from the bar line chart:

Eye Colour	Tally Marks	Frequency
Blue	### ### II	12
Hazel	### III	8
Brown	### ### ###	15
Green	###	5
Total		40

How many adults were asked?
40

2 more adults with blue eyes were added to the data,

Would the most popular eye colour change? **No, Brown is still the most popular.**

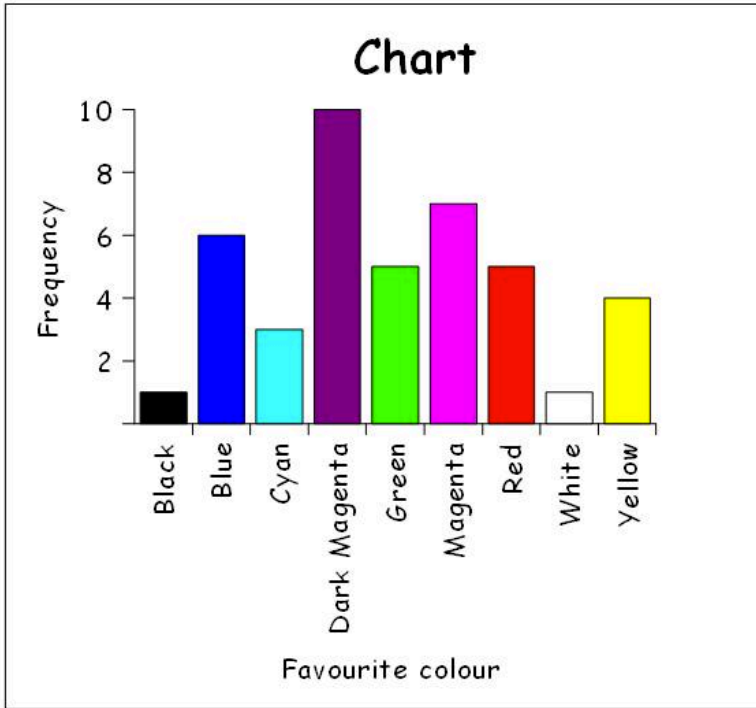

Chloe has created a bar chart using the information in the frequency table below:

Favourite Colour	Tally Marks	Frequency
Black		1
Blue		6
Cyan		2 3
Dark Magenta		10
Green		5
Magenta		7
Red		6 5
White		1
Yellow		4
Total		42

Has she made any mistakes?

(Circle any mistakes and write the correction).

Extension Questions

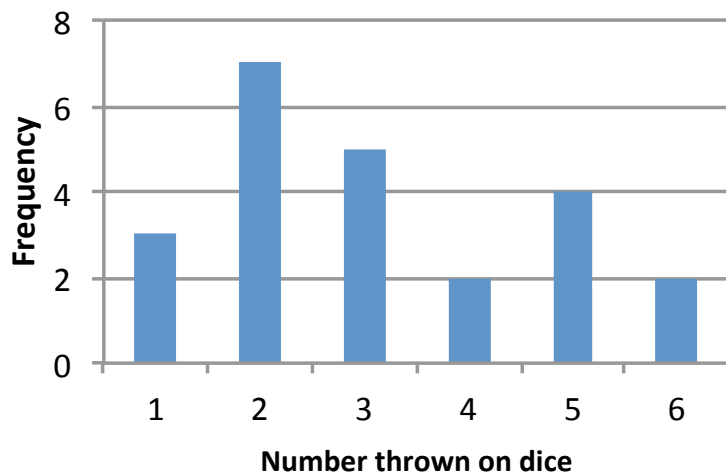

Which number was thrown most often?

2

How many times was the dice thrown?

$$3 + 7 + 5 + 2 + 4 + 2 = 23$$

If you get a prize of 50p every time you throw a number **greater than 4**, how much money would you have after these throws? **This happens 6 times.**

$$50p \times 6 = 300p = \text{£}3$$

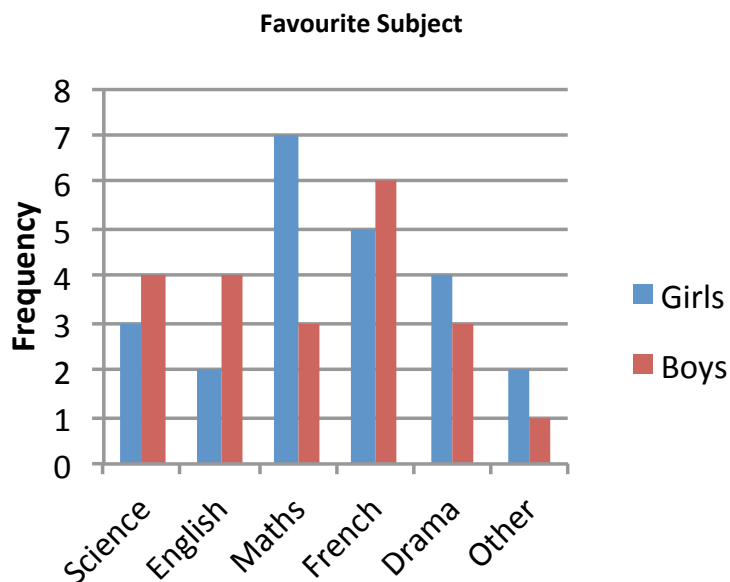

True or False

Girls' favourite subject is Maths. **True**

More boys than girls chose science. **True**

Maths is the most popular subject in the class. **False** **French is the most popular**

How many girls are there? **23**

How many students chose 'other'?

$$2 + 1 = 3 \text{ students}$$

Past Paper Question

Sophie asked the students in her class how they travelled to school.

The bar chart shows some information about the results, for everyone in Sophie's class.

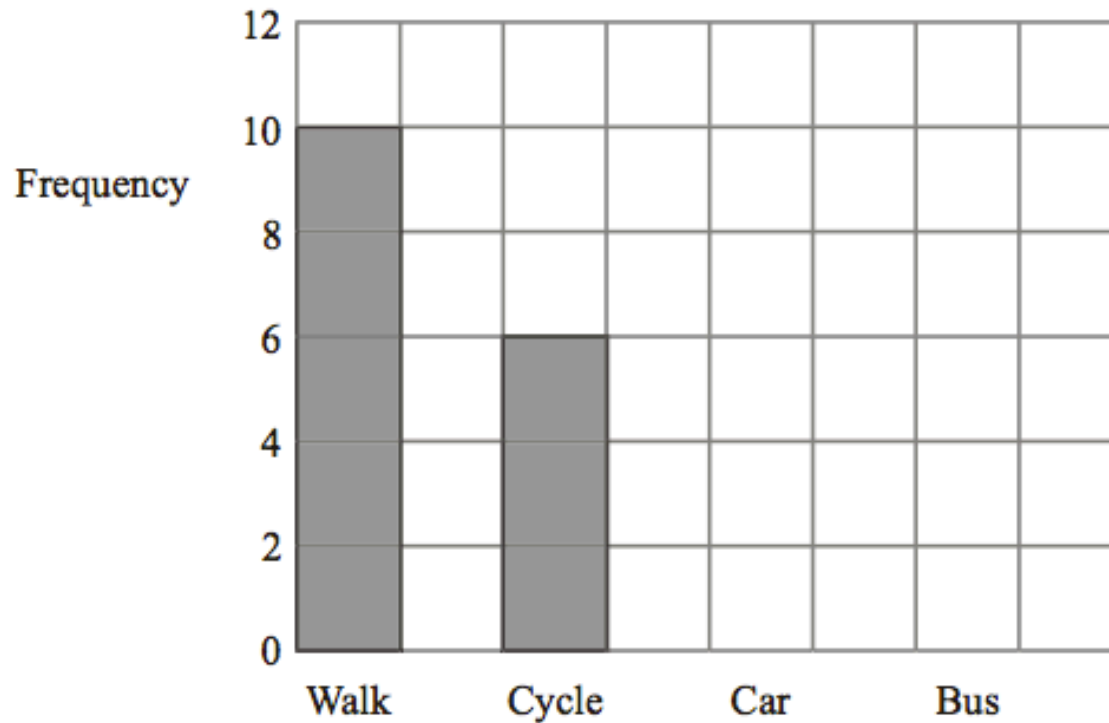

4 students travel to school by car.

7 students travel to school by bus.

(a) Complete Sophie's bar chart.

(2)

(b) How many students in Sophie's class cycle to school?

.....

(1)

(c) Which method of travelling to school is used by the greatest number of students in Sophie's class?

.....

(1)

(d) Work out the total number of students Sophie asked.

.....

(1)

(Total 5 marks)

Past Paper Question

Sophie asked the students in her class how they travelled to school.

The bar chart shows some information about the results, for everyone in Sophie's class.

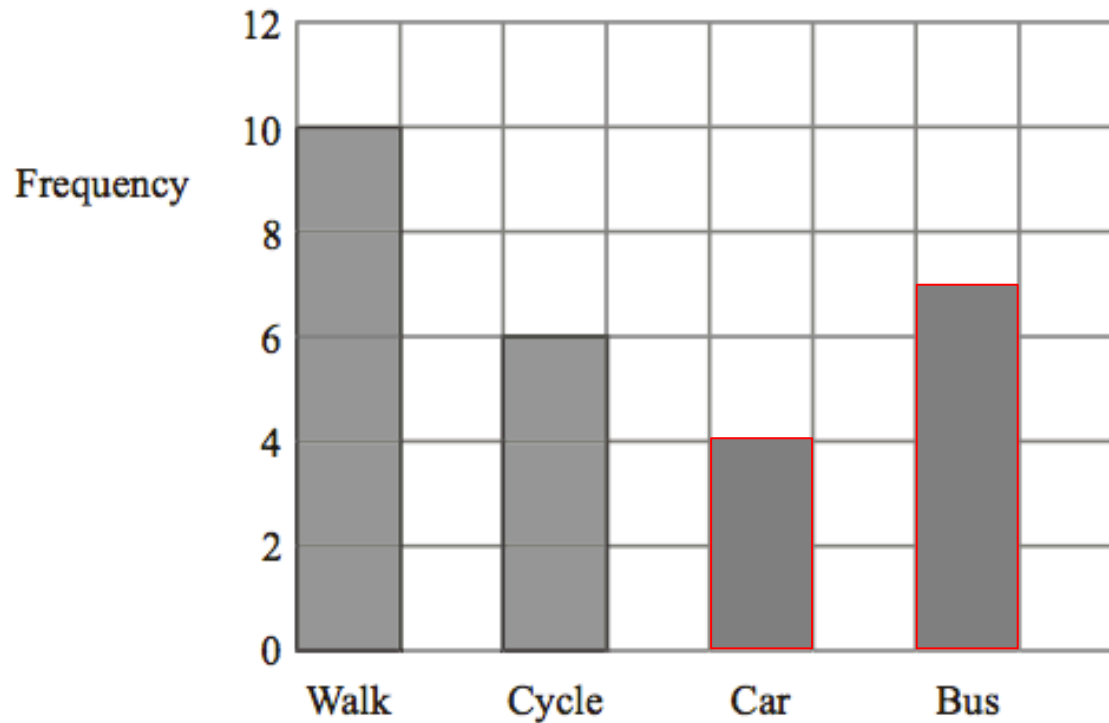

4 students travel to school by car.

7 students travel to school by bus.

(a) Complete Sophie's bar chart.

(2)

(b) How many students in Sophie's class cycle to school?

6

.....

(1)

(c) Which method of travelling to school is used by the greatest number of students in Sophie's class?

Walking

.....

(1)

(d) Work out the total number of students Sophie asked.

$$10 + 6 + 4 + 7 = 27$$

27

.....

(1)

(Total 5 marks)